

LB Submersible Portable Dewatering Pump

- **LB-250/480** ● **LBT-250/480**
- **LB-250A/480A** ● **LBZ-480**
- **LB-800** ● **LBT-800**
- **LB-800A** ● **LBZ-800**

OPERATION MANUAL

INTRODUCTION

Thank you for selecting the Tsurumi LB Submersible General Dewatering Portable Pump for your application.

This equipment should not be used for applications other than those listed in this manual. Failure to observe this precaution may lead to a malfunction or an accident. In the event of a malfunction or an accident, the manufacturer will not assume any liability. After reading this Operation Manual, keep it in a location that is easily accessible, so that it can be referred to whenever information is needed while operating the equipment.

CONTENTS

1. BE SURE TO READ FOR SAFTY	1
2. PART NAMES.....	4
3. PRIOR TO OPERATION	4
4. INSTALLATION	5
5. ELECTRICAL WIRING	8
6. OPERATION.....	10
7. MAINTENANCE AND INSPECTION.....	14
8. DISASSEMBLY AND REASSEMBLY PROCEDURE.....	16
9. TROUBLESHOOTING	18

安全須知	i
為確保您的安全請務必閱讀下列資訊	ii
HÃY ĐỌC KỸ ĐỂ ĐẢM BẢO AN TOÀN CHO BẠN	iii
กรุณาอ่านข้อความนี้เพื่อความปลอดภัยของคุณ	iv
PASTIKAN UNTUK MEMBACA DEMI KESELAMATAN ANDA	v
PASTIKAN ANDA MEMBACA UNTUK KESELAMATAN ANDA	vi
SIGURUHING BASAHIN PARA SA SARILING KALIGTASAN	vii
تأكد من القراءة من أجل سلامتك	viii
ASEGÚRESE DE LEER LA SIGUIENTE INFORMACIÓN PARA SU SEGURIDAD	ix
ASSUREZ-VOUS DE LIRE CE DOCUMENT POUR VOTRE SÉCURITÉ	x
ОБЯЗАТЕЛЬНО ПРОЧИТАЙТЕ ДЛЯ ВАШЕЙ СОБСТВЕННОЙ БЕЗОПАСНОСТИ	xi

安全须知

- 请勿在任何非规定条件下操作本产品。不遵守此注意事项可能会导致漏电、触电、火灾、溢水或其他问题。
- 如果水池或水坑中有人，切勿尝试操作本产品。如果发生漏电，则会造成触电。
- 请勿在铭牌上所示电压（电压容许限度为 $\pm 5\%$ 以内）除外的任何电压下操作本产品。如果使用发电机进行操作，强烈建议不要使用同一发电机操作其他设备。否则可能造成产品故障和损坏，从而导致漏电或触电。
- 所有电气工程（包括电缆延伸）都必须由授权电工进行，并遵照贵国的所有现行法规。切勿允许未授权人员进行电气工程，因为这不仅违法，而且极其危险。
- 请务必提供适合泵的专用接地漏电断路器（额定灵敏电流不得超过 30 mA）和热过载继电器（两者均为市售品）。不遵守此警告会在发生产品故障或漏电时造成触电或爆炸。
- 请提供本产品专用的可靠接地点。请勿将地线连接到煤气管、水管、避雷针或电话地线。接地不当会造成触电。
- 请勿使用已损坏或装配不紧密的电缆、电源插头或电源插座。损坏的电缆必须由有资格的人员进行更换。请将电缆的每根导线牢固连接至各端子。否则会导致触电、短路或火灾。
- 切勿将电缆的末端或电源插头浸入水中。这可能会导致产品损坏、漏电、触电或火灾。
- 请勿擦伤、折叠、拉扯、扭曲、改装或捆扎电缆，或将其用作吊具。否则电缆可能会损坏，因而造成漏电、短路、触电或火灾。
- 开始维护或检查之前，请务必关闭电源或断开插头，这样泵就不会意外启动。请勿湿手作业。若不遵守这些注意事项可能导致触电或伤害。

為確保您的安全請務必閱讀下列資訊

- 請勿在指定狀況之外的任何狀況下操作本產品。若不遵守本注意事項可能導致漏電、電擊、火災、溢水或其他問題。
- 若水池或集水坑中有人，絕勿嘗試操作本產品。萬一發生漏電，可能造成電擊。
- 請勿在銘牌上所述電壓（容許限度 $\pm 5\%$ ）之外的任何電壓之下操作本產品。若用發電機來進行操作，強烈建議勿以相同發電機操作其他設備。若不遵守本注意事項可能造成產品故障和損壞，進而導致漏電或電擊。
- 所有電氣工作（包括纜線延長）必須由獲授權電工依據貴國所有適用法規來執行。絕勿允許未獲授權人員執行電氣工作，因為這不僅違法，更是極度危險。
- 請務必提供適合泵的專用接地漏電斷路器（具有不超過 30 mA 的額定靈敏度電流）以及熱過載繼電器（這兩種裝置可在市面上買到）。若不依循本警告事項，產品發生故障或漏電時，可能造成電擊或爆炸。
- 請為本產品提供專用的可靠接地點。請勿將接地線連接到瓦斯管、水管、避雷針或電話接地線。接地不當可能造成電擊。
- 如果纜線、電源插頭或電源插座損壞或無法緊密吻合，請勿使用。損壞的纜線必須由合格人員予以更換。請將纜線的每一根導線安全連接到端子上。若未能遵守這一點，可能造成電擊、短路或火災。
- 絕勿將纜線末端或電源插頭浸入水中。否則可能造成產品損壞、漏電、電擊或火災。
- 請勿刮傷、折疊、拉動、扭轉、改裝或捆束纜線，或將纜線作為吊具使用。否則纜線可能損壞，進而造成漏電、短路、電擊或火災。
- 開始維護或檢查之前，請務必關閉電源或拔出插頭，以避免泵意外啟動。請勿以濕手工作。若不遵守這些注意事項，可能造成電擊或傷害。

HÃY ĐỌC KỸ ĐỂ ĐẢM BẢO AN TOÀN CHO BẠN

- Không vận hành sản phẩm trong bất kỳ điều kiện nào ngoài những điều kiện được chỉ định. Không tuân thủ các quy tắc phòng ngừa có thể dẫn đến rò rỉ điện, điện giật, hỏa hoạn, tràn nước hoặc các vấn đề khác.
- Tuyệt đối không cố vận hành sản phẩm khi có người tại hồ nước hoặc bể chứa. Nếu rò rỉ điện xảy ra, có thể gây điện giật.
- Không vận hành sản phẩm ở điện áp khác với điện áp được ghi trên tem nhãn với giới hạn dung sai điện áp trong khoảng $\pm 5\%$. Nếu vận hành với máy phát điện, chúng tôi đặc biệt khuyến cáo bạn không nên vận hành thiết bị nào khác với cùng máy phát điện này. Không tuân thủ các quy tắc phòng ngừa có thể gây ra trục trặc và hư hỏng sản phẩm, điều này có thể dẫn đến rò rỉ điện hay điện giật.
- Tất cả các công việc liên quan đến điện (bao gồm cả nối dài cáp) phải được thực hiện bởi thợ điện có chuyên môn và phải tuân thủ tất cả các quy định tại quốc gia của bạn. Tuyệt đối không được để một người thợ điện không có chuyên môn thực hiện công việc này vì điều này không chỉ trái pháp luật mà còn có thể cực kỳ nguy hiểm.
- Nhất định phải sử dụng cầu dao chống rò điện đất chuyên dụng (có độ nhạy dòng điện không vượt quá 30 mA) và rơ le nhiệt bảo vệ quá tải phù hợp với máy bơm (cả hai đều có sẵn trên thị trường). Không tuân thủ theo cảnh báo này có thể gây điện giật hoặc cháy nổ khi sản phẩm hư hỏng hoặc xảy ra rò rỉ điện.
- Sử dụng thiết bị nối đất an toàn chuyên dụng cho sản phẩm. Không gắn dây nối đất với ống dẫn ga, ống nước, cột thu lôi hoặc dây nối đất của điện thoại. Nối đất không đúng cách có thể gây điện giật.
- Không sử dụng dây cáp, phích cắm điện hoặc ổ cắm điện nếu các thiết bị này bị hỏng hay không được gắn chặt. Cáp bị hỏng phải được thay bởi thợ có tay nghề. Kết nối tất cả dây dẫn của cáp với các thiết bị đầu cuối một cách chắc chắn. Không tuân thủ các bước này có thể dẫn đến giật điện, chập điện hoặc hỏa hoạn.
- Tuyệt đối không để các đầu dây cáp hoặc phích cắm điện bị nhúng nước. Điều này có thể làm hư hỏng sản phẩm, rò rỉ điện, giật điện hoặc hỏa hoạn.
- Không làm xước, gập, kéo, xoắn, làm biến dạng hoặc bó các sợi cáp, hoặc sử dụng dây cáp như một thiết bị nâng. Dây cáp có thể bị hư hỏng, dẫn đến các sự cố rò rỉ điện, chập điện, giật điện hoặc hỏa hoạn.
- Trước khi bắt đầu bảo trì hay kiểm tra, nhất định phải tắt nguồn điện hoặc rút phích cắm điện, tránh trường hợp máy bơm vô tình khởi động. Không làm việc với tay ướt. Không tuân thủ các bước này có thể dẫn đến giật điện hoặc bị thương.

กรุณาอ่านข้อความนี้เพื่อความปลอดภัยของคุณ

- ห้ามใช้งานผลิตภัณฑ์ภายใต้สภาวะอื่นใดนอกเหนือจากที่ระบุไว้ หากไม่สามารถปฏิบัติตามข้อควรระวัง อาจส่งผลให้เกิดไฟรั่ว ไฟช็อต เพลิงไหม้ น้ำล้น หรือปัญหาอื่น ๆ ได้
- ห้ามพยายามใช้งานผลิตภัณฑ์หากมีบุคคลอื่นอยู่ในสระน้ำหรือบ่อน้ำ เนื่องจากหากเกิดไฟรั่วขึ้น อาจทำให้เกิดไฟช็อตได้
- ห้ามใช้งานผลิตภัณฑ์ภายใต้แรงดันไฟฟ้าอื่นใดนอกเหนือจากที่ระบุไว้บนป้าย ซึ่งมีเกณฑ์ความปลอดภัยเคลื่อนของแรงดันไฟฟ้าอยู่ที่ $\pm 5\%$ หากมีการใช้งานกับเครื่องกำเนิดไฟฟ้า แนะนำเป็นอย่างยิ่งว่าไม่ให้ใช้งานกับอุปกรณ์อื่นด้วยเครื่องกำเนิดไฟฟ้าเครื่องเดียวกัน หากไม่สามารถปฏิบัติตามคำเตือนนี้ อาจส่งผลให้เกิดการทำงานผิดปกติ และผลิตภัณฑ์พังเสียหาย ซึ่งส่งผลให้เกิดไฟรั่วหรือไฟช็อตได้
- งานด้านไฟฟ้าทั้งหมด(รวมไปถึงการต่อสายเคเบิล) จะต้องดำเนินการโดยช่างไฟฟ้าที่ได้รับอนุญาต ซึ่งเป็นการปฏิบัติตามระเบียบที่มีการกำหนดไว้ในประเทศของคุณ ห้ามไม่ให้ผู้ที่ไม่ได้รับอนุญาตดำเนินงานด้านไฟฟ้าโดยเด็ดขาด เพราะไม่เพียงแต่จะเป็นการฝ่าฝืนกฎหมาย แต่ยังสามารถเกิดอันตรายอย่างยิ่งได้ด้วย
- จัดให้มีการใช้เบรกเกอร์แบบมีระบบสายดินโดยเฉพาะ (โดยมีกระแสรั่วไหลได้ไม่เกิน 30mA) และใช้อิโวลต์รีเลย์แบบทำงานด้วยความร้อนที่เหมาะสมกับขนาดของบีม (อุปกรณ์ทั้งสองชนิดนี้จะมีจำหน่ายทั่วไป) หากไม่สามารถปฏิบัติตามสัญญาณเตือนนี้ อาจส่งผลให้เกิดไฟช็อต หรือระเบิดเมื่อผลิตภัณฑ์ไม่สามารถทำงาน หรือเกิดไฟรั่วได้
- จัดให้มีระบบสายดินที่ปลอดภัยสำหรับผลิตภัณฑ์นี้โดยเฉพาะ ห้ามเชื่อมต่อสายดินเข้ากับท่อก๊าซ ท่อน้ำ สายล่อฟ้า หรือสายดินของโทรศัพท์ ระบบสายดินที่ไม่เหมาะสมอาจทำให้เกิดไฟช็อตได้
- ห้ามใช้สายเคเบิล ปลั๊กไฟ หรือเต้าเสียบที่ชำรุดหรือหลวม สำหรับสายเคเบิลที่ชำรุดจะต้องมีการเปลี่ยนด้วยบุคลากรที่มีคุณสมบัติครบถ้วน ให้เชื่อมต่อสายตัวนำทุกตัวของสายเคเบิลเข้ากับขั้วต่อให้แน่นหนา หากไม่สามารถปฏิบัติตามได้ อาจส่งผลให้เกิดไฟช็อต ไฟลัดวงจร หรือเพลิงไหม้ได้
- ห้ามจุ่มปลายของสายเคเบิลหรือปลั๊กไฟลงในน้ำโดยเด็ดขาด การกระทำดังกล่าวอาจส่งผลให้ผลิตภัณฑ์ชำรุดเสียหาย ไฟรั่ว ไฟช็อต หรือเพลิงไหม้ได้
- ห้ามครูด พับ ดึง บิด ตัดแปลง หรือมัดรวมสายเคเบิล หรือใช้เป็นอุปกรณ์สำหรับยกของ สายเคเบิลอาจชำรุด ซึ่งเป็นเหตุให้เกิดไฟรั่ว ไฟลัดวงจร ไฟช็อต หรือเพลิงไหม้ได้
- ก่อนเริ่มการซ่อมบำรุงหรือตรวจสอบใดๆ ให้ปิดแหล่งจ่ายไฟให้สนิทหรือถอดปลั๊ก เพื่อป้องกันไม่ให้บีมเริ่มทำงานโดยบังเอิญ และห้ามใช้งานขณะมือเปียก หากไม่สามารถปฏิบัติตามคำเตือนเหล่านี้ อาจส่งผลให้เกิดไฟช็อต หรือเกิดการบาดเจ็บได้

PASTIKAN UNTUK MEMBACA DEMI KESELAMATAN ANDA

- **Jangan operasikan produk dalam kondisi apa pun selain dari yang ditentukan. Kegagalan untuk mematuhi tindakan pencegahan dapat menyebabkan kebocoran listrik, sengatan listrik, kebakaran, luapan air atau masalah lainnya.**
- **Jangan pernah mencoba mengoperasikan produk jika seseorang berada di kolam atau wadah minyak. Jika terjadi kebocoran listrik, hal itu dapat menyebabkan sengatan listrik.**
- **Jangan operasikan produk dalam tegangan apa pun selain yang dijelaskan pada papan nama dengan batas toleransi tegangan $\pm 5\%$. Jika dioperasikan dengan generator, sangat disarankan untuk tidak mengoperasikan peralatan lain dengan generator yang sama. Kegagalan mematuhi peringatan ini dapat menyebabkan kegagalan fungsi dan kerusakan produk, yang dapat menyebabkan kebocoran listrik atau sengatan listrik.**
- **Semua pekerjaan listrik (termasuk ekstensi kabel) harus dilakukan oleh ahli listrik yang berwenang, sesuai dengan semua peraturan yang berlaku di negara Anda. Jangan pernah mengizinkan orang yang tidak berwenang melakukan pekerjaan listrik karena tidak hanya melanggar hukum, tetapi juga bisa sangat berbahaya.**
- **Benar-benar menyediakan pemutus sirkuit kebocoran tanah khusus (memiliki arus sensitivitas terukur tidak melebihi 30 mA) dan relai kelebihan beban termal yang cocok untuk pompa (keduanya tersedia di pasar). Gagal mengikuti peringatan ini dapat menyebabkan sengatan listrik atau ledakan ketika produk gagal atau terjadi kebocoran listrik.**
- **Berikan pentanahan aman yang didedikasikan untuk produk. Jangan hubungkan kabel arde ke pipa gas, pipa air, penangkal petir, atau kabel arde telepon. Pentanahan yang tidak benar dapat menyebabkan sengatan listrik.**
- **Jangan gunakan kabel, steker listrik, atau stopkontak jika rusak atau tidak dipasang dengan erat. Kabel yang rusak harus diganti oleh orang yang berwenang. Hubungkan setiap konduktor kabel dengan aman ke terminal. Kegagalan untuk mengamati ini dapat menyebabkan sengatan listrik, hubungan pendek, atau kebakaran.**
- **Jangan pernah merendam ujung kabel atau steker listrik ke dalam air. Ini dapat menyebabkan kerusakan pada produk, kebocoran listrik, sengatan listrik, atau kebakaran.**
- **Jangan menggores, melipat, menarik, memelintir, membuat perubahan, atau mengikat kabel, atau menggunakannya sebagai alat pengangkat. Kabel mungkin rusak, yang dapat menyebabkan kebocoran listrik, hubungan pendek, sengatan listrik, atau kebakaran.**
- **Sebelum memulai perawatan atau inspeksi, matikan catu daya sepenuhnya atau lepaskan steker sehingga pompa tidak dapat memulai secara tidak sengaja. Jangan bekerja dengan tangan basah. Gagal mematuhi peringatan ini dapat menyebabkan sengatan listrik atau cedera.**

PASTIKAN ANDA MEMBACA UNTUK KESELAMATAN ANDA

- **Jangan mengoperasikan produk dalam keadaan apa-apa syarat selain daripada yang dinyatakan. Kegagalan untuk mematuhi langkah berjaga-jaga boleh menyebabkan kebocoran elektrik, kejutan elektrik, kebakaran, limpahan air atau masalah lain.**
- **Jangan pernah cuba mengoperasikan produk jika ada orang di kolam atau baki. Sekiranya kebocoran elektrik berlaku, ia boleh menyebabkan kejutan elektrik.**
- **Jangan operasikan produk di bawah mana-mana voltan selain daripada yang dinyatakan pada papan nama dengan had toleransi voltan $\pm 5\%$. Jika ia dioperasikan dengan generator, sangat disyorkan untuk tidak mengoperasikan peralatan lain dengan generator yang sama. Kegagalan mematuhi amaran ini boleh menyebabkan pincang tugas dan kerosakan produk, yang mungkin menyebabkan kebocoran elektrik atau kejutan elektrik.**
- **Semua kerja elektrik (termasuk sambungan kabel) mesti dilakukan oleh juruelektrik yang diberi kuasa, selaras dengan semua peraturan yang berlaku di negara anda. Jangan sekali-kali membenarkan seseorang yang tidak dibenarkan melakukan kerja elektrik kerana ia bukan sahaja melanggar undang-undang, tetapi ia juga boleh menjadi sangat berbahaya.**
- **Pastikan untuk benar memberikan pemutus litar kebocoran bumi khusus (mempunyai kepekaan arus yang tidak melebihi 30 mA) dan relai beban lebih terma yang sesuai untuk pam (kedua-duanya terdapat di pasaran). Kegagalan mematuhi peringatan ini boleh menyebabkan kejutan atau letupan elektrik apabila produk gagal atau kebocoran elektrik berlaku.**
- **Sediakan grounding yang selamat untuk produk. Jangan sambungkan dawai tanah ke paip gas, paip air, tongkat cahaya, atau dawai tanah telefon. Grounding yang salah boleh menyebabkan kejutan elektrik.**
- **Jangan gunakan kabel, palam kuasa atau soket kuasa jika rosak atau tidak dipasang dengan teliti. Kabel yang rosak mesti diganti oleh orang yang berkelulusan. Sambung setiap konduktor kabel dengan selamat ke terminal. Kegagalan mematuhi perkara ini boleh menyebabkan kejutan elektrik, litar pintas, atau kebakaran.**
- **Jangan menenggelamkan hujung kabel atau palam kuasa di dalam air. Ini boleh mengakibatkan kerosakan produk, kebocoran elektrik, kejutan elektrik, atau kebakaran.**
- **Jangan menggores, melipat, tarik, memutar, membuat perubahan, atau mengikat kabel, atau menggunakannya sebagai peranti untuk mengangkat. Kabel mungkin akan rosak, yang boleh menyebabkan kebocoran elektrik, litar pintas, kejutan elektrik, atau kebakaran.**
- **Sebelum memulakan penyenggaraan atau pemeriksaan, matikan bekalan kuasa sepenuhnya atau cabut palam supaya pam tidak boleh bermula secara tidak sengaja. Jangan bekerja dengan tangan basah. Kegagalan mematuhi peringatan ini boleh membawa kepada kejutan atau kecederaan elektrik.**

SIGURUHING BASAHIN PARA SA SARILING KALIGTASAN

- **Huwag gamitin ang produkto sa anumang kondisyon maliban sa itinakdang gamit nito. Kapag hindi sinunod ang mga babala, maaaring maging sanhi ito ng pagkakaroon ng electrical leakage, electrical shock, sunog, pag-apaw ng tubig at iba pang mga problema.**
- **Huwag gamitin ang produkto kapag may tao sa loob ng pool o balon. Maaaring maging sanhi ng electrical shock kapag nagkaroon ng electrical leakage.**
- **Huwag gamitin ang produkto sa anumang boltahe maliban sa itinakdang boltahe na nakalarawan sa nameplate na may voltage tolerance limit na nasa loob ng $\pm 5\%$. Kapag ginamitan ng generator, mahigpit na ipinapayo na iwasan ang paggamit ng ibang kagamitan sa parehong generator. Kapag hindi sinunod ang mga babala, maaaring masira o hindi gumana nang husto ang produkto, at maging sanhi ng pagkakaroon ng electrical leakage o electrical shock.**
- **Ang lahat ng gawain kaugnay sa elektrisidad (pati ang cable extension) ay kailangang gawin ng isang authorized electrician, sang-ayon sa mga naaangkop na regulasyon sa sariling bansa. Huwag itong ipagawa sa isang taong walang sapat na kuwalipikasyon sa paggawa ng electrical work, dahil hindi lamang ito labag sa batas kundi masyadong mapanganib.**
- **Kailangang maglaan ng isang dedicated earth leakage circuit breaker (na may rated sensitivity current na hindi lalampas sa 30 mA) at may thermal overload relay na nababagay sa pump (ibinibenta sa mga tindahan). Kapag hindi sinunod ang mga babala, maaaring maging sanhi ito ng pagkakaroon ng electrical shock o pagsabog sa kapag nagkaroon ng problema sa produkto o kapag nagkaroon ng electrical leakage.**
- **Gumawa ng isang secure grounding para lamang sa produkto. Huwag ikabit ang ground wire sa tubo ng gas o tubig, lightning rod, o telephone ground wire. Maaaring maging sanhi ng electrical shock ang hindi pagtatag ng tamang grounding.**
- **Huwag gumamit ng cable, power plug, or power outlet kapag ito ay sira na, o kapag hindi maayos ang pagkakakabit nito. Ang pagpalit ng cable ay kailangang gawin ng isang taong may sapat na kuwalipikasyon. Ikabit nang maigi ang bawat conductor ng cable sa mga terminals. Kapag hindi sinunod ang mga babala, maaaring maging sanhi ito ng pagkakaroon ng electrical shock, short circuit o sunog.**
- **Huwag ilubog sa tubig ang dulo ng cable o power plug. Maaari itong maging sanhi ng pagkasira ng produkto, pagkakaroon ng electrical leakage, electrical shock, o sunog.**
- **Huwag gasgasin, tupiin, hilahin, ibaluktot, baguhin o ibigkis ang cable o di kaya'y gamitin ito bilang isang lifting device. Maaaring masira ang cable, na maging sanhi ng pagkakaroon ng electrical leakage, short circuit, electrical shock, o sunog.**
- **Bago umpisahan ang maintenance o pagsusuri, kailangang patayin ang power supply o tanggalin ang plug upang maiwasan ang hindi sinasadyang pag-andar ng pump. Huwag gumawa kapag basa ang mga kamay. Kapag hindi sinunod ang mga babala, maaaring maging sanhi ito ng pagkakaroon ng electrical shock, o pagkapinsala.**

تأكد من القراءة من أجل سلامتك

- لا تقم بتشغيل المنتج تحت أية ظروف بخلاف تلك المحددة له. قد يؤدي عدم مراعاة الاحتياطات إلى حدوث تسرب كهربائي أو صدمة كهربائية أو نشوب حريق أو فيضان الماء أو وقوع مشكلات أخرى.
- لا تحاول مطلقاً تشغيل المنتج عند وجود شخص ما في حمام السباحة أو في الحوض. إذا حدث تسرب كهربائي، فقد يتسبب في صدمة كهربائية.
- لا تقم بتشغيل المنتج تحت أي جهد بخلاف ما هو موضح على اللوحة، على أن يكون حد تحمل الجهد ضمن $\pm 5\%$. إذا تم تشغيله باستخدام مولد، يُنصح بشدة بعدم تشغيل معدات أخرى باستخدام نفس المولد. عدم مراعاة هذا التنبيه قد يؤدي إلى حدوث خلل للمنتج وتعطله، مما قد يؤدي بدوره إلى حدوث تسرب كهربائي أو صدمة كهربائية.
- يجب أن يقوم كهربائي معتمد بتنفيذ جميع الأعمال الكهربائية (هما في ذلك توصيل الكابلات)، وفقاً لجميع اللوائح المعمول بها في بلدك. لا تسمح أبداً لشخص غير معتمد بأداء الأعمال الكهربائية ليس فقط لكون ذلك مخالفاً للقانون، بل لأنه قد يشكل خطورة شديدة أيضاً.
- قم بتجهيز قاطع دائرة تسرب أرضي مخصص (به تيار حساسية مُقدَّر لا يتجاوز 30 مللي أمبير) ومرحل حراري يعمل عند تجاوز الحمل مناسب للمضخة (كلاهما متاح في السوق). قد يؤدي عدم اتباع هذا التحذير إلى حدوث صدمة كهربائية أو انفجار إذا فشل المنتج في أداء وظيفته أو إذا حدث تسرب كهربائي.
- قم بتوفير تأريض آمن مخصص للمنتج. لا تقم بتوصيل سلك التأريض بأنبوب غاز أو أنبوب ماء أو مانع صواعق أو سلك تأريض الهاتف التأريض بطريقة غير سليمة قد يسبب صدمة كهربائية.
- لا تستخدم الكابل أو قابس الطاقة أو مأخذ الطاقة إذا كان تالفاً أو إذا لم يكن مركباً بإحكام. يجب أن يتم استبدال الكابل التالف بواسطة شخص مؤهل. قم بتوصيل كل موصل من موصلات الكابل إلى الأطراف بشكل آمن. عدم مراعاة هذا قد يؤدي إلى حدوث صدمة كهربائية أو دائرة قصر أو نشوب حريق.
- لا تعتمد مطلقاً على غمر طرفي الكابل أو قابس الطاقة في الماء. قد يؤدي هذا إلى تلف المنتج أو حدوث تسرب كهربائي أو صدمة كهربائية أو نشوب حريق.
- لا تعتمد على خدش الكابل أو طيه أو سحبه أو ثنيه أو إجراء تعديلات عليه أو تجميعه، أو استخدامه كجهاز رفع. قد يكون الكابل تالفاً مما قد يتسبب في حدوث تسرب كهربائي أو دائرة قصر أو صدمة كهربائية أو نشوب حريق.
- قبل بدء الصيانة أو الفحص، قم بقطع تزويد الطاقة بالكامل أو قم بفصل القابس حتى لا يبدأ تشغيل المضخة بشكل غير مقصود. لا تقم بمباشرة العمل حين تكون يداك مبللتين. عدم مراعاة هذه التنبيهات قد يؤدي إلى حدوث صدمة كهربائية أو إصابة.

ASEGÚRESE DE LEER LA SIGUIENTE INFORMACIÓN PARA SU SEGURIDAD

- **No manipule el producto en condiciones distintas a las que ha sido diseñado. El incumplimiento de esta precaución puede ocasionar fugas eléctricas, descargas eléctricas, incendios, desbordamientos de agua u otros problemas.**
- **Nunca intente manipular el producto si hay alguien presente en la pileta (piscina) o sumidero. Una fuga eléctrica puede ocasionar una descarga eléctrica.**
- **No manipule el producto en un voltaje diferente al indicado en la placa de identificación. Utilícelo dentro del rango de tolerancia de voltaje de $\pm 5\%$. Si se manipula con un generador, se recomienda encarecidamente no operar otros equipos con el mismo generador. El incumplimiento de esta precaución puede causar el mal funcionamiento y la falla del producto, lo que podría ocasionar fugas o descargas eléctricas.**
- **Todos los trabajos de electricidad (incluida la instalación del cable de extensión) deben ser realizados por un electricista autorizado, en conformidad con las regulaciones aplicables en su país. Nunca permita que una persona no autorizada realice trabajos eléctricos porque, no solo es ilegal, sino que puede ser extremadamente peligroso.**
- **Asegúrese de instalar un disyuntor específico de fuga a tierra (con sensibilidad nominal no superior a 30 mA) y un relé de sobrecarga térmica adecuado para la bomba (ambos disponibles en el mercado). El incumplimiento de esta advertencia puede ocasionar descargas eléctricas o explosiones cuando el producto falla o se produce una fuga eléctrica.**
- **Instale una conexión a tierra segura y específica para el producto. No conecte el cable de tierra a una tubería de gas, tubería de agua, pararrayos o cable de tierra del teléfono. Una conexión a tierra incorrecta podría causar descargas eléctricas.**
- **No utilice el cable, el enchufe o la toma de corriente si están dañados o si no están bien ajustados. Los cables dañados deben ser reemplazados por una persona calificada. Conecte cuidadosamente cada conductor del cable a los terminales. De lo contrario, se podrían producir descargas eléctricas, cortocircuitos o incendios.**
- **Nunca sumerja los extremos de un cable o el enchufe en agua. Esto podría ocasionar daños en el producto, fugas eléctricas, descargas eléctricas o incendios.**
- **No raye, doble, hale, tuerza, altere ni enrolle el cable, ni lo use como dispositivo de elevación. El cable podría dañarse, ocasionando fugas eléctricas, cortocircuitos, descargas eléctricas o incendios.**
- **Antes de comenzar el mantenimiento o la inspección, asegúrese de apagar la fuente de alimentación o desconectar el enchufe para que la bomba no arranque accidentalmente. No trabaje con las manos mojadas. El incumplimiento de estas precauciones podría ocasionar descargas eléctricas o lesiones.**

ASSUREZ-VOUS DE LIRE CE DOCUMENT POUR VOTRE SÉCURITÉ

- **N'utilisez pas le produit dans des conditions autres que celles pour lesquelles il est spécifié. Le non-respect de cette précaution peut entraîner une dispersion électrique, une électrocution, un incendie, une inondation ou d'autres problèmes.**
- **N'essayez jamais de faire fonctionner le produit si quelqu'un est présent dans la piscine ou le puisard. Si une dispersion électrique se produit, cela peut provoquer une électrocution.**
- **Ne faites pas fonctionner le produit sous une tension autre que celle indiquée sur la plaque signalétique dans une limite de tolérance inférieure à $\pm 5\%$. Si vous utilisez un groupe électrogène, il est fortement recommandé de ne pas utiliser d'autres équipements avec le même groupe électrogène. Le non-respect de cet avertissement peut provoquer un dysfonctionnement et une panne de l'appareil, pouvant entraîner une dispersion électrique ou une électrocution.**
- **Tous les travaux électriques (y compris l'extension des câbles) doivent être effectués par un électricien agréé, conformément à toutes les réglementations en vigueur dans votre pays. Ne permettez jamais à une personne non autorisée d'effectuer des travaux électriques, car non seulement c'est illégal, mais cela peut aussi être extrêmement dangereux.**
- **Prévoir absolument un disjoncteur différentiel dédié (avec une sensibilité nominale ne dépassant pas 30 mA) et un relais thermique de surcharge adapté à la pompe (tous deux disponibles dans le commerce). Le non-respect de cet avertissement peut provoquer une électrocution ou une explosion en cas de défaillance du produit ou de dispersion électrique.**
- **Fournir une mise à la terre sécurisée dédiée au produit. Ne branchez pas le fil de terre à une conduite de gaz ou d'eau, à un paratonnerre ou à un fil de terre de téléphone. Une mise à la terre incorrecte peut provoquer une électrocution.**
- **N'utilisez pas le câble, la fiche d'alimentation ou la prise de courant s'ils sont endommagés ou s'ils ne sont pas bien fixés. Tout câble endommagé doit être remplacé par une personne qualifiée. Raccordez solidement chaque conducteur du câble aux bornes. Le non-respect de cette consigne peut entraîner une électrocution, un court-circuit ou un incendie.**
- **Ne jamais immerger les extrémités d'un câble ou la fiche d'alimentation dans l'eau. Cela pourrait endommager l'appareil, provoquer une dispersion électrique, une électrocution ou un incendie.**
- **Ne pas érafler, plier, tirer, tordre, modifier, mettre en faisceau le câble ou l'utiliser comme dispositif de levage. Le câble peut être endommagé, ce qui peut provoquer une dispersion électrique, un court-circuit, une électrocution ou un incendie.**
- **Avant de commencer l'entretien ou l'inspection, coupez impérativement l'alimentation électrique ou débranchez la prise afin que la pompe ne puisse pas démarrer accidentellement. Ne travaillez pas avec les mains mouillées. Le non-respect de ces mises en garde peut entraîner une électrocution ou des blessures.**

ОБЯЗАТЕЛЬНО ПРОЧИТАЙТЕ ДЛЯ ВАШЕЙ СОБСТВЕННОЙ БЕЗОПАСНОСТИ

- Не пользуйтесь изделием в условиях, отличных от тех, для которых оно предназначено. Несоблюдение данных мер предосторожности может привести к утечке тока, поражению электрическим током, пожару, переливу воды или другим проблемам.
- Никогда не пытайтесь использовать изделие, если кто-либо присутствует в бассейне или сточном колодце. Утечка тока может привести к поражению электрическим током.
- Не используйте изделие под напряжением, отличным от указанного на заводской табличке, при допустимом отклонении напряжения в пределах $\pm 5\%$. Если он работает с генератором, настоятельно рекомендуется не использовать другое оборудование с тем же генератором. Несоблюдение данной меры предосторожности может стать причиной неисправности и повреждения изделия, что может привести к утечке или поражению электрическим током.
- Все электромонтажные работы (включая удлинение кабеля) должны выполняться уполномоченным электриком в соответствии со всеми действующими правилами вашей страны. Никогда не позволяйте посторонним лицам выполнять электромонтажные работы, поскольку это не только противоречит закону, но и может быть чрезвычайно опасным.
- Чрезвычайно необходимо предоставить специальный автоматический выключатель для защиты от утечки на землю (имеющий номинальную чувствительность тока не более 30 мА) и тепловое реле перегрузки, подходящее для насоса (оба доступны в продаже). Несоблюдение этого предупреждения может привести к поражению электрическим током или взрыву в случае выхода из строя изделия либо утечки тока.
- Обеспечьте безопасное заземление, предназначенное для изделия. Не подключайте заземляющий провод к газовой трубе, водопроводу, молниеотводу или телефонному заземляющему проводу. Ненадлежащее заземление может привести к поражению электрическим током.
- Не используйте кабель, вилку или розетку, если они повреждены или не плотно прилегают. Поврежденный кабель должен быть заменен квалифицированным персоналом. Надежно подключите каждую жилу кабеля к клеммам. Несоблюдение этого требования может привести к поражению электрическим током, короткому замыканию или возгоранию.
- Никогда не погружайте концы кабеля или вилку в воду. Это может привести к повреждению изделия, утечке тока, поражению электрическим током или пожару.
- Не царапайте, не складывайте, не тяните, не скручивайте, не вносите изменения, не связывайте кабель и не используйте его в качестве подъемного устройства. Кабель может быть поврежден, что может привести к утечке тока, короткому замыканию, поражению электрическим током или пожару.
- Перед началом технического обслуживания или проверки обязательно отключите электропитание или отсоедините штепсельную вилку таким образом, чтобы насос случайно не запустился. Не производите работу мокрыми руками. Несоблюдение данных мер предосторожности может привести к поражению электрическим током или травме.



1 BE SURE TO READ FOR YOUR SAFETY

Be sure to thoroughly read and understand the SAFETY PRECAUTIONS given in this section before using the equipment in order to operate the equipment correctly.

The precautionary measures described in this section are intended to prevent danger or damage to you or to others. The contents of this manual that could possibly be performed improperly are classified into two categories: **⚠ WARNING**, and **⚠ CAUTION**. The categories indicate the extent of possible damage or the urgency of the precaution. Note however, that what is included under **⚠ CAUTION** may at times lead to a more serious problem. In either case, the categories pertain to safety-related items, and as such, must be observed carefully.

- **⚠ WARNING** : Operating the equipment improperly by failing to observe this precaution may possibly lead to death or injury to humans.
- **⚠ CAUTION** : Operating the equipment improperly by failing to observe this precaution may possibly cause injury to humans and other physical damage.
- **NOTE** : Gives information that does not fall in the WARNING or CAUTION categories.





● **Explanation of Symbols:**







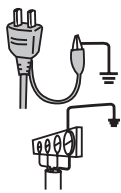



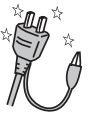

-  : The \triangle mark indicates a WARNING or CAUTION item. The symbol inside the mark describes the precaution in more detail ("electrical shock", in the case of the example on the left).
-  : The \circ mark indicates a prohibited action. The symbol inside the mark, or a notation in the vicinity of the mark describes the precaution in more detail ("disassembly prohibited", in the case of the example on the left).
-  : The \bullet mark indicates an action that must be taken, or instructs how to perform a task. The symbol inside the mark describes the precaution in more detail ("provide ground work", in the case of the example on the left).

PRECAUTIONS TO THE PRODUCT SPECIFICATIONS















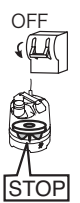

⚠ CAUTION	
	<p>● Do not operate the product under any conditions other than those for which it is specified. Failure to observe the precaution can lead to electrical leakage, electrical shock, fire, water overflow or other problems.</p>
	



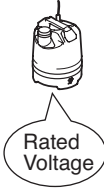





PRECAUTIONS DURING TRANSPORT AND INSTALLTION

⚠ WARNING	
<p>● When transporting the product, pay close attention to its center of gravity and mass. Use an appropriate lifting equipment to lift the unit. Improper lifting may result in the fall of the product which could cause damage of the product or human injury.</p> 	<p>● Install the product properly in accordance with this instruction manual. Improper installation may result in electrical leakage, electrical shock, fire, water leakage, or injury.</p> 
<p>● Electrical wiring should be performed in accordance with all applicable regulations in your country. Absolutely provide a dedicated earth leakage circuit breaker and a thermal overload relay suitable for the product (available on the market). Imperfect wiring or improper protective equipment can lead to electrical leakage, fire, or explosion in the worst case.</p> 	<p>● Provide a secure grounding dedicated for the product. Never fail to provide an earth leakage circuit breaker and a thermal overload relay in your starter or control panel (Both available on the market). If an electrical leakage occurs due to a product failure, it may cause electrical shock.</p> 
<p>● Use a power outlet that has a sufficient rating and has been exclusively provided for the pump. If the power outlet is shared with other equipment, it can lead to an abnormal heat of the outlet and can cause fire as a result.</p>	<p style="text-align: center;">Power Supply Capacity </p>











 CAUTION			
	<p>● Be sure to provide a ground wire securely. Do not connect the ground wire to a gas pipe, water pipe, lightning rod, or telephone ground wire. Improper grounding could cause electrical shock.</p> 		<p>● Prevent a metallic object or dust from sticking to the power plug. Adhesion of foreign object to the plug could cause electrical shock, short-circuit, or fire.</p> 
	<p>● Do not scratch, fold, twist, make alterations, or bundle the cable, or use it as a lifting device. The cable may be damaged, which may cause electrical leakage, short-circuit, electrical shock, or fire.</p> 		<p>● Do not use the cable, power plug, or power outlet if it is damaged or it is not closely fitted. Connect every conductor of the cable securely to the terminals. Failure to observe this can lead to electrical shock, short-circuit, or fire.</p> 
	<p>● This pump is neither dust-proof nor explosion-proof. Do not use it at a dusty place or at a place where toxic, corrosive or explosive gas is present. Use in such places could cause fire or explosion.</p> 		<p>● When the product will be carried by hand, decide the number of persons considering the mass of the product. When lifting up the product, do not attempt to do it by simply bowing from the waist. Use the knees, too, to protect your back.</p> 





PRECAUTIONS DURING TEST OPERATION AND OPERATION

 WARNING			
	<p>● Never try to operate the pump if somebody is present in the pump sump. If an electrical leakage occurs, it can cause electrical shock.</p> 		<p>● Never start the pump while it is suspended, as the unit may jerk and could lead to injury.</p> 
	<p>● When changing power connection is needed to correct the direction of rotation, be sure to turn off the power supply (earth leakage circuit breaker, etc.), and perform the work after making sure that the impeller has stopped completely. Failure to do so may lead to electrical shock, short-circuit, or injury.</p> 		<p>● When inspecting the pump, be sure to turn off the power supply (earth leakage circuit breaker, etc.) so that the pump may not start accidentally. Failure to do so may lead to a serious accident.</p> 
 CAUTION			
	<p>● Do not operate the product under any voltage other than described on the nameplate with the voltage tolerance limit within $\pm 5\%$. If it is operated with a generator, it is strongly suggested not to operate other equipment with the same generator. Failure to observe this caution may cause malfunction and breakdown of the product, which may lead to electrical leakage or electrical shock.</p> 		<p>● Do not touch the product with bare hands during or immediate after the operation, as the product may become very hot during operation. Failure to observe this caution may lead to burn.</p> 
	<p>● Do not use the product in a liquid other than water. Use in oil, salt water or organic solvents will damage it, which may lead to electrical leakage or electrical shock.</p> 		<p>● Do not run the product dry or operate it with its gate valve closed, as doing so will damage the product, which may lead to electrical leakage or electrical shock.</p> 





 CAUTION	
	<ul style="list-style-type: none"> Do not use the product for hot or warm liquid over 40°C, as doing so will damage the product, which may lead to electrical leakage or electrical shock. 
	<ul style="list-style-type: none"> Do not allow foreign object (pin, wire, etc.) to enter the suction inlet of the pump. Failure to observe this caution could cause it to malfunction or to operate abnormally, which may lead to electrical leakage or electrical shock. 
	
<ul style="list-style-type: none"> When the product will not be used for an extended period, be sure to turn off the power supply (earth leakage circuit breaker, etc.). Deterioration of the insulation may lead to electrical leakage, electrical shock, or fire.  	

PRECAUTIONS DURING MAINTENANCE AND INSPECTION





 WARNING	
	<ul style="list-style-type: none"> Absolutely turn off the power supply or disconnect the plug before starting maintenance or inspection. Do not work with wet hands. Failure to observe these cautions may lead to electrical shock or injury.   
	<ul style="list-style-type: none"> In case any abnormality (excessive vibration, unusual noise or odor) is found in the operation, turn the power off immediately and consult with the dealer where it was purchased or Tsurumi representative. Continuing to operate the product under abnormal conditions may result in electrical shock, fire, or water leakage.   
	
<ul style="list-style-type: none"> Do not disassemble or repair any parts other than those designated in the operation manual. If repairs are necessary in any other than the designated parts, consult with the dealer where it was purchased or Tsurumi representative. Improper repairs can result in electrical leakage, electrical shock, fire, or water leakage. 	



 CAUTION	
	<ul style="list-style-type: none"> After reassembly, always perform a test operation before resuming use of the product. Improper assembly can result in electrical leakage, electrical shock, fire, or water leakage.  

PRECAUTION TO POWER OUTAGE

 WARNING	
	<ul style="list-style-type: none"> In case of power outage, turn off the power supply. The product will resume operation when the power is restored, which presents serious danger to people in the vicinity.  

OTHER PRECAUTION

 CAUTION	
	<ul style="list-style-type: none"> Never use the product for potable water. It may present a danger to human health.  

 CAUTION	
	<ul style="list-style-type: none"> This appliance is not intended for use by persons (including children) with reduced physical, sensory or mental capabilities, or lack of experience and knowledge, unless they have been given supervision or instruction concerning use of the appliance by a person responsible for their safety. Children should be supervised to ensure that they do not play with the appliance. If the supply cord is damaged, it must be replaced by the manufacturer, its service agent or similarly qualified persons in order to avoid a hazard. Pollution of the liquid could occur due to leakage of lubricants. The pump must be supplied through a residual current device (RCD) having a rated residual operating current not exceeding 30 mA.

2 PART NAMES

Example

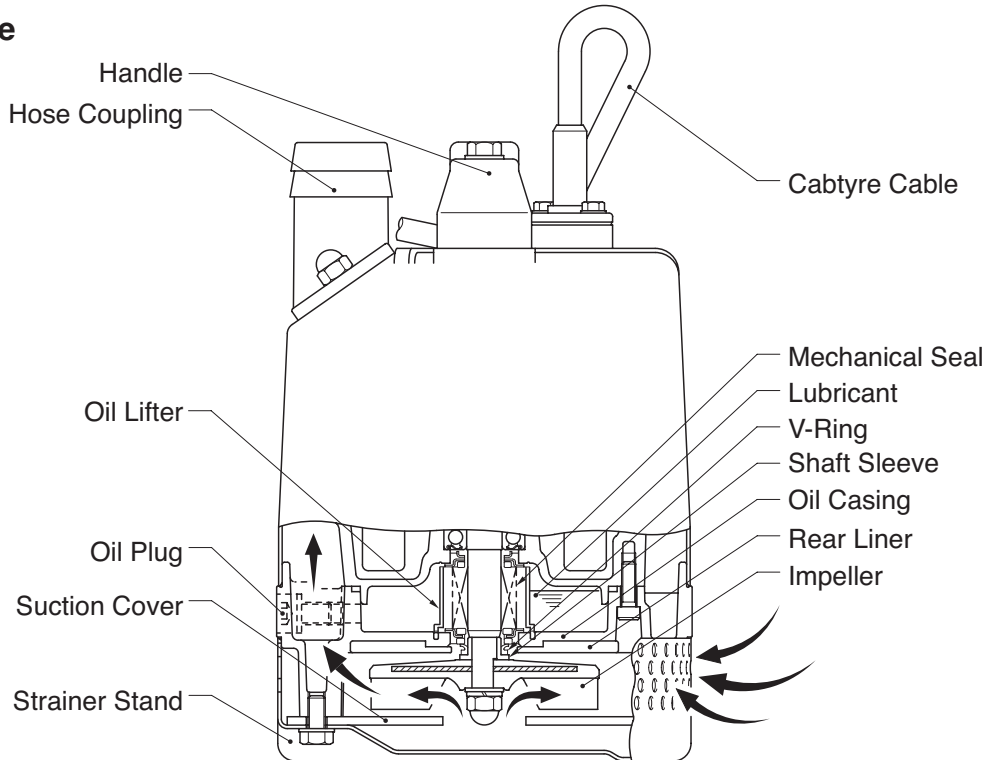

3 PRIOR TO OPERATION

After unpacking, verify the contents.

Product Inspection

Inspect the product for damage during shipment, and make sure all bolts and nuts are tightened properly.

Specification Check

Check the nameplate of the unit to verify that it is the product that you have ordered. Pay particular attention to its voltage and frequency specifications.

Example of nameplate

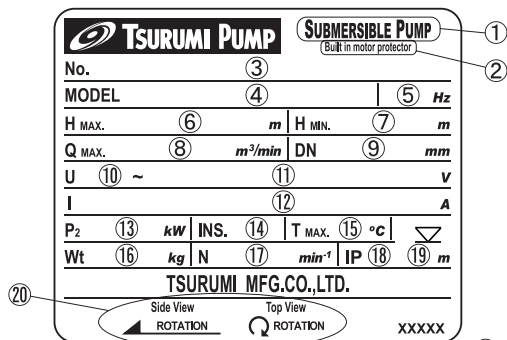

1	Submersible pump	11	Rated voltage
2	Built in motor protector	12	Rated current
3	Serial number	13	Rated output power
4	Model	14	Insulation class
5	Frequency	15	Max. liquid temperature
6	Max. total head	16	Weight without cable
7	Min. total head	17	Speed of rotation
8	Max. flow rate	18	IP degree of protection
9	Discharge bore	19	Max. immersion depth
10	Phase	20	Direction of rotation

④		⑤ Hz		SUBMERSIBLE PUMP (Built in motor protector)		IP ⑱	∑ ⑲ m
DN ⑨ mm	P ₂ ⑬ kW	U ⑩ ~	⑪ V				
H _{MAX.} ⑥ m	Q _{MAX.} ⑧ m ³ /min	I ⑫	A				
H _{MIN.} ⑦ m	N ⑰ min ⁻¹	TSURUMI Mfg.Co.,Ltd.					
Wt ⑯ kg	INS. ⑭	T _{MAX.} ⑮ °C	XXXXX				

Note: If you discover any damage or discrepancy in the product, please contact the dealer where this equipment was purchased or the Tsurumi sales office in your area.

Accessory Check

Verify that all accessory items are included in the package.

- Hose Band 1 pc - Models for US are excluded
- Operation Manual 1

Note: *If you discover any damage or discrepancy in the product, please contact the dealer where this equipment was purchased or the Tsurumi sales office in your area.*

Product Specifications

CAUTION Do not operate this product under any conditions other than those that have been specified.

Major Standard Specifications

Fluid	Property	Water, Rain Water, Font Water, Sand carrying Water, Ground Water ; 0 ~ 40°C
Pump	Impeller	Semi-Vortex Type
	Shaft Seal	Double Mechanical Seal
	Bearing	Shielded Ball Bearing
Motor	Specifications	Dry Submersible Induction Motor, 2-Pole
	Insulation	Class E
	Protection System (built-in)	Miniature protector [LB-250(A),LB-480(A)(Z)] Circle thermal protector (other models)
	Lubricant	Turbine oil VG32 (non-additive)
Connection		Hose Coupling

Standard specifications (50/60Hz)

Model	Bore mm	Phase	Starting Method	Output kW	Max.Head m ft.	Max.capacity m ³ /min GPM	WHT kg
LB-250	40	1	Capacitor-Run	0.25	8.8/8.6 28.9/28.2	0.190 50.2	10.4
LBT-250	40	3	Direct-on-line	0.25	8.8/8.6 28.9/28.2	0.190 50.2	10.0
LB-480	50	1	Capacitor-Run	0.48	11.0/12.0 36.1/39.5	0.220/0.240 58.1/63.4	10.4
LBT-480	50	3	Direct-on-line	0.48	11.0/12.0 36.1/39.5	0.220/0.240 58.1/63.4	10.0
LB-250A	40	1	Capacitor-Run	0.25	8.8/8.6 28.9/28.2	0.190 50.2	11.0
LB-480A	50	1	Capacitor-Run	0.48	11.0/12.0 36.1/39.5	0.220/0.240 58.1/63.4	11.0
LBZ-480	50	1	Capacitor-Run	0.48	11.0/12.0 36.1/39.5	0.220/0.240 58.1/63.4	10.4
LB-800	50	1	Capacitor-Run	0.75	15.0/18.0 49.0/59.0	0.31 82.0	13.1
LBT-800	50	3	Direct-on-line	0.75	15.0/18.0 49.0/59.0	0.31 82.0	12.4
LB-800A	50	1	Capacitor-Run	0.75	15.0/18.0 49.0/59.0	0.31 82.0	13.7
LBZ-800	50	1	Capacitor-Run	0.75	15.0/18.0 49.0/59.0	0.31 82.0	13.1

Note: *The weight (mass) given above is the operating weight of the pump itself, not including the cabtyre cable.*

4 INSTALLATION

CAUTION

- The supply voltage should be within $\pm 5\%$ of the rated voltage.
- The water temperature for operating the pump should be between 0 ~ 40°C. Failure to observe the precautions given above could cause the pump to malfunction, which may lead to current leakage or electrical shock.

Note: *To use the pump for a special solution, contact the dealer where it was purchased, or the Tsurumi sales office in your area.*

Critical Use Pressure

CAUTION Do not operate the pump in an area that is exposed to a water pressure that exceeds the values given below.

Critical Use Pressure	0.2MPa (2kgf/cm ²) – discharge pressure during use
-----------------------	--

Preparation for Installation

Single-phase power supply:

Use a megger to measure the resistance between the tip of the cabtyre cable plug and the ground terminal to verify the insulation resistance of the motor.

Measure twice the resistance between each of the two tips of the plug and ground.

(This diagram shows a 2-pin plug type.)

Single-Phase

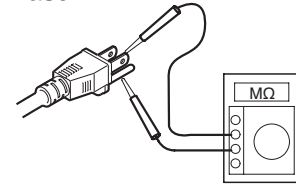

CAUTION Beware that the power plug varies by country or region.

Three-phase power supply:

Use a megger to measure the resistance between each core of the cabtyre cable and the (green) ground wire to verify the insulation resistance of the motor.

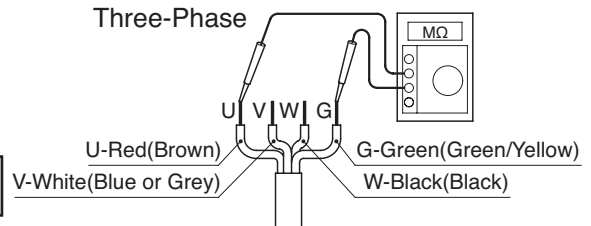

Insulation resistance reference value = 20MΩ minimum

Note: The insulation resistance reference value of 20MΩ minimum is based on a new or repaired pump. For reference values of a pump that has already been put into operation, refer to "7. Maintenance and Inspection" of this manual.

How to use level relay unit (LB-250A/480A/800A)

CAUTION

- Do not measure the insulation resistance with insulation resistance tester for following parts. It causes a trouble.
- Do not lift or hang the level relay unit. It will damage and cause a leakage, an electric shock, and a fire.
- In the case of the float type, do not lift it by the float cable, as it will damage the cable, and lead to a leakage, electrical shock, and fire.

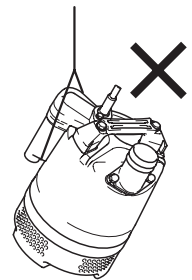

(1) between the plug

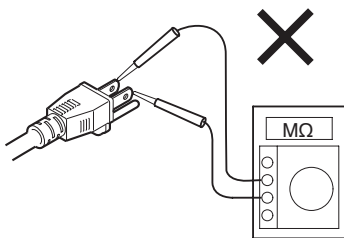

(2) between the electrode of a level relay unit

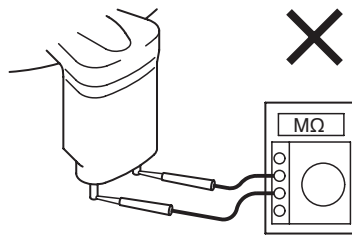

(3) between the electrode of a level relay unit and a plug

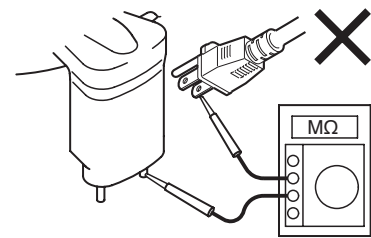

(4) Do not make "on" period between the other level relay unit.

Precautions During Installation

WARNING When installing the pump, be mindful of the pump's center of gravity and weight. If the pump is not suspended properly, the pump may fall and break, which may lead to injury.

CAUTION When installing or moving the pump, never suspend the pump by the cabtyre cable. Doing so will damage the cable, which may cause a current leakage, electrical shock, or fire.

(1) When a hose is used, attach the hose to the hose coupling as far as it will go, then fasten it securely with a hose band.

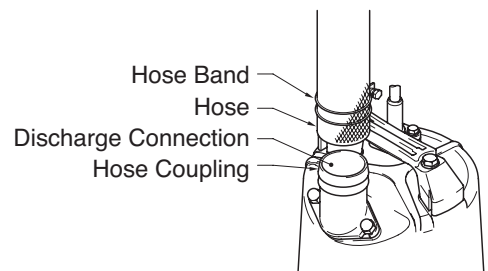

- (2) Handle the pump carefully without applying shock to it, such as by dropping it. To suspend the pump, do so manually or by attaching a rope or chain to its handles.

CAUTION The rope for suspending the pump during its installation must be of a thickness that accommodates the weight of the pump. When using a chain, make sure that the chain does not become twisted. Failure to observe these precautions could cause the rope or chain to break and the pump to fall and break, which could lead to personal injury.

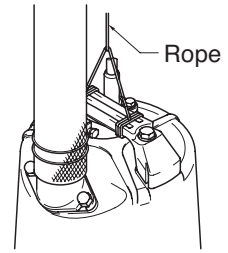

- (3) Operate the pump in a location that has a sufficient water level and collects water easily.

Note: For the water level required for operating the pump, refer to the external dimension drawing, which is provided separately. Extend the end of the hose (discharge side) above the water surface. If the end of the hose is submerged in water, it may cause the water to flow back when the pump has been stopped. Conversely, if the end of the hose is located at a level that is lower than the source water surface, water may continue to flow out even after the pump has been stopped.

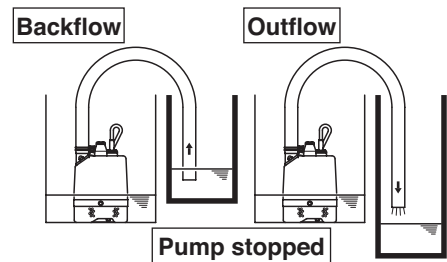

- (4) Route the hose as straight as possible. Excessive bending of the hose could obstruct the flow of water, reduce the pumping volume, or clog the pump with mud, thus disabling the pumping function. If the hose is kinked at its base, it will create air pockets in the pump, causing the pump to operate dry. To prevent this from occurring, straighten the bend while operating the pump.

If the hose becomes kinked as shown in (A), reposition the hose coupling so that it faces as shown in (B). Loosen the cap nut on the hose coupling to change its direction.

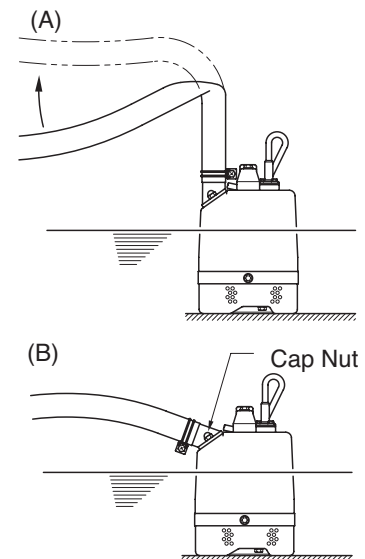

CAUTION If the pump draws in a large amount of mud, it could cause the pump to wear prematurely and lead to a malfunction, current leakage, and electrical shock.

- (5) Operate the pump upright. If there is the likelihood of the pump drawing in excess mud, place a concrete block under the pump.

Installing the Float

Set the length of the float lead wire to the dimension indicated below. Failure to observe this will lead to an improper operation.

Pump model	L
LBZ-480	150mm
LBZ-800	200mm

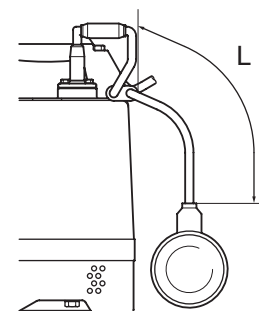

5 ELECTRICAL WIRING

Electrical Wiring Work

- ⚠ WARNING**
- All electrical work must be performed by an authorized electrician, in compliance with local electrical equipment standards and internal wiring codes. Never allow an unauthorized person to perform electrical work because it is not only against the law, but it can also be extremely dangerous.
 - Improper wiring can lead to current leakage, electrical shock, or fire.
 - Absolutely provide a dedicated earth leakage circuit breaker and a thermal overload really suitable for the pump(available on the market). Failure to follow this warning can cause electrical shock or explosion when the product fails or an electrical leakage occurs.

Operate well within the capacity of the power supply and wiring.

Grounding

- ⚠ WARNING** Be sure to install the ground wire securely. Failure to observe this precaution could damage the pump and cause current leakage, which may lead to electrical shock.

- ⚠ CAUTION** Do not connect the ground wire to a gas pipe, water pipe, lightning rod, or telephone ground wire. Improper grounding could cause electrical shock.

Connecting the Power Plug

- ⚠ WARNING** Before inserting the power plug or connecting the wires to the terminal board, make sure that the power supply (i.e. circuit breaker) is properly disconnected. Failure to do so may lead to electrical shock, short, or injury caused by the unintended starting of the pump.

- ⚠ CAUTION** Do not use damaged cable cables, power plugs, or loose power outlets. Failure to observe this precaution could lead to electrical shock, short circuit, or fire.

Follow the diagram on the right to connect the power.

When using a three-prong grounded plug, connect as shown in the drawing.

- ⚠ CAUTION** Be sure to use a dedicated power supply with a ground leakage circuit breaker.

(This diagram shows a 2-pin plug type.)

- ⚠ CAUTION** Beware that the power plug varies by country or region.

Note: *The shape of the plug may differ from that shown in the illustration.*

When a single-phase power source is used, connect the leads to the control panel terminals as shown in the diagram, making sure they do not become twisted together.

When a three-phase power source is used, connect the leads to the control panel terminals as shown in the diagram, making sure they do not become twisted together.

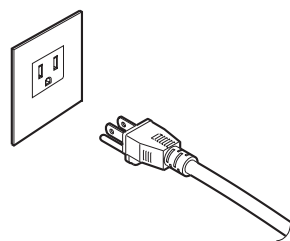

Single Phase

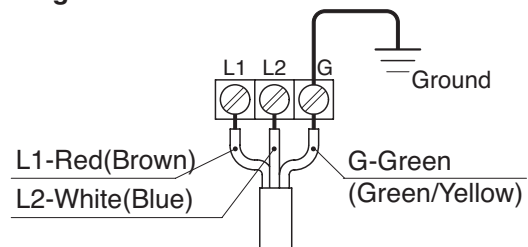

Three Phase

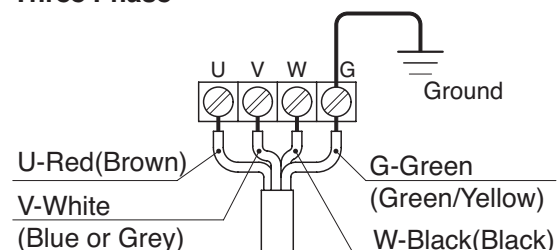

Motor Protector

The pump is equipped with an internal motor protector.(Circle Thermal Protector / Miniature Protector)

If a current overload or overheating occurs under the symptoms given below, the motor will stop automatically to protect the motor regardless of the water level at the time of operation.

In this type of motor protector, the motor will automatically restart after cooling down. If the motor is stopped by protector tripping, turn off the power supply first, and disconnect the cables from the power terminals. After this, make sure to eliminate the cause of the problem, such as the following:

- Extreme fluctuation of power supply voltage
- Pump operated under overload condition
- Pump operated at open phase or binding condition

⚠ WARNING If repair or maintenance is attempted with cables connected to power supply, unintended automatic restarting of the motor may cause human injury.

Electrical Circuit Diagrams

Non-Automatic Circuit

LB-250 , LB-480

Power Supply: Single-Phase

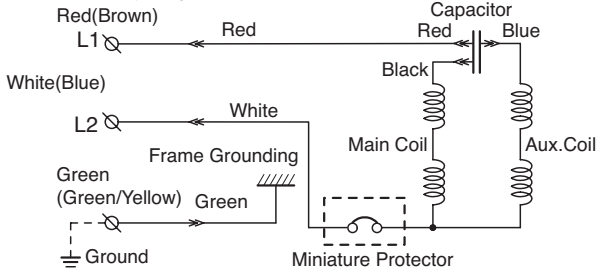

Non-Automatic Circuit

LB-800

Power Supply: Single-Phase

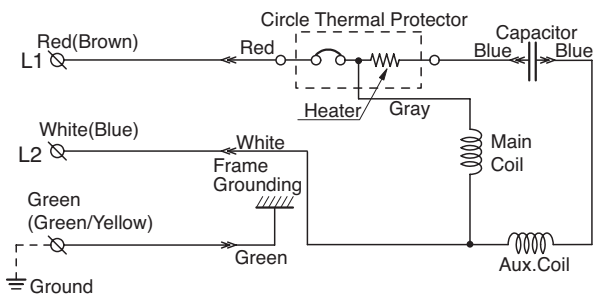

Automatic Operation Circuit (for electrode type)

LB-800A

Power Supply: Single-Phase

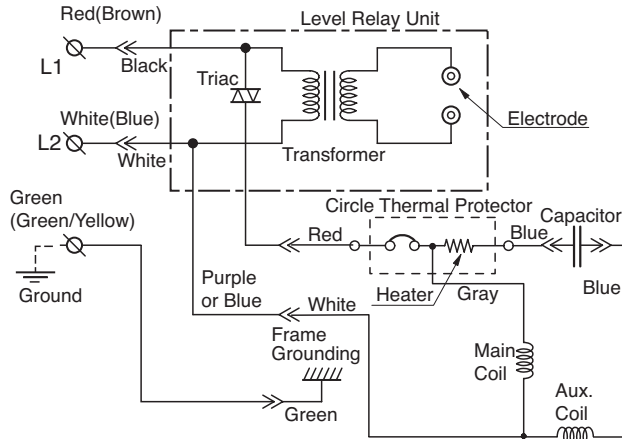

Non-Automatic Circuit

LBT-250 , LBT-480 , LBT-800

Power Supply: Three-Phase

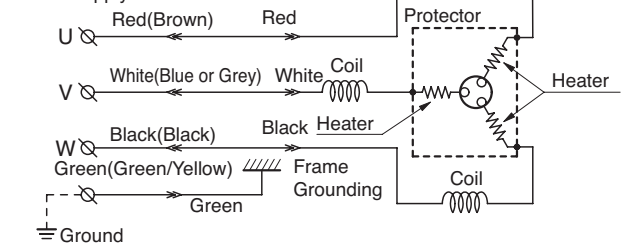

Automatic Operation Circuit (Level Relay Unit)

LB-250A , LB-480A

Power Supply: Single-Phase

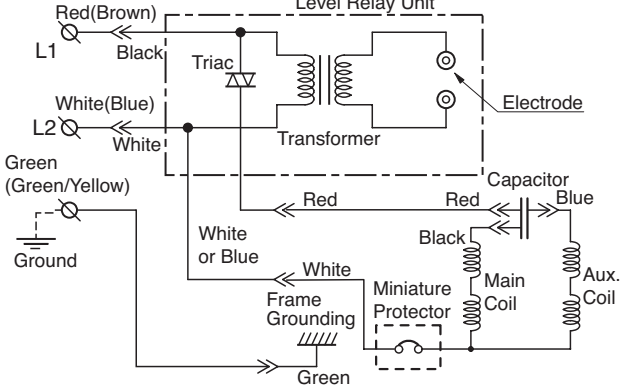

Automatic Operation Circuit (for float type)

LBZ-480

Power Supply: Single-Phase

Single-Phase

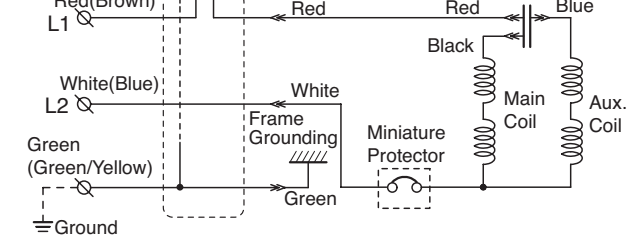

Automatic Operation Circuit (for float type)

LBZ-800

Power Supply: Single-Phase

Single-Phase

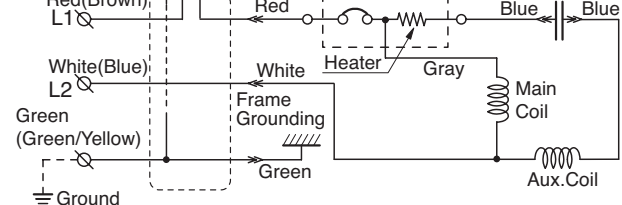

6 OPERATION

Prior to Operation

- (1) Once again, check the nameplate of the pump to verify that its voltage and frequency are correct.

CAUTION Improper voltage and frequency of the power supply will prevent the pump from attaining its full potential, and may also damage the pump.

Note: Verify the specs on the pump's nameplate.

- (2) Check the wiring, power supply voltage, the capacity of the ground leakage circuit breaker, and the insulation resistance of the motor.

■ Insulation resistance reference value = 20MΩ minimum

Note: The insulation resistance reference value of 20MΩ minimum is based on a new or repaired pump. For reference values of a pump that has already been put into operation, refer to "Maintenance and Inspection".

- (3) Adjust the setting of the thermal relay (i.e. 3E relay) to the pump's rated current.

Note: Verify the rated current on the pump's nameplate.

- (4) When using a generator, as much as possible avoid operating the pump in conjunction with other types of equipment.

6-1 NON-AUTOMATIC OPERATION

Trial Operation

WARNING Never start the pump while it is suspended, as the pump may jerk and cause a serious accident involving injury.

- (1) Operate the pump for a short time (1 to 2 seconds) and verify the direction of the rotation of the impeller. Observe the pump unit from above, and if its recoil is in the counterclockwise direction, the direction of its rotation is correct.

CAUTION Make sure to check the pump's direction of rotation with the pump exposed to the atmosphere. Operating the pump in reverse while it is submerged in water will damage the pump, which may lead to current leakage and electrical shock.

- (2) [three-phase models] To reverse the rotation, the following countermeasures must be taken.

WARNING Before changing the connections for reverse rotation, make sure that the power supply (i.e. circuit breaker) is properly disconnected and that the impeller has stopped completely. Failure to observe this may lead to electrical shock, short, or injury.

COUNTERMEASURE

Interchange any two of the three wires designated U, V, and W, respectively.

Note: [single-phase models] If the pump does not rotate correctly, please contact the store where you purchased this machine or the Tsurumi sales office in your area.

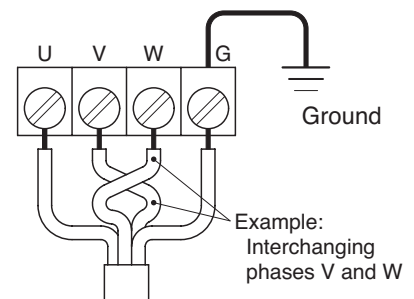

- (3) Connect the pump to the pipe and submerge it in water.
- (4) Operate the pump for a short time (3 to 10 minutes) and perform the following checks:

Using an AC ammeter (clamp), measure the operating current at the phases U, V, and W that are connected to the terminal board.

COUNTERMEASURE

Because an overload condition may be present at the pump motor if the operating current exceeds the rated current, follow the instructions in section "4. Installation" to operate the pump in the correct manner.

Using an AC voltmeter (tester), measure the voltage at the terminal board.

■ Power supply voltage tolerance = within $\pm 5\%$ of the rated voltage

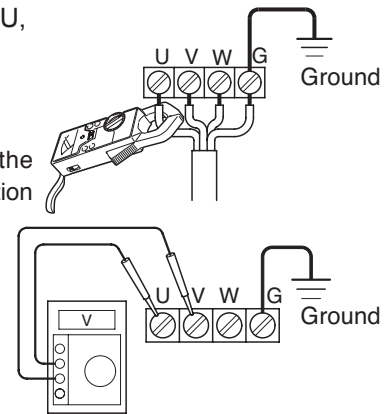

COUNTERMEASURE

If the power supply voltage deviates from the variation value, the cause of the deviation may be the capacity of the power supply or the extension cable that is used. Refer to section "5. Electrical Wiring" to operate the pump in the correct manner.

CAUTION

In case the pump exhibits an abnormal condition (such as a considerable amount of vibration, noise, or smell), disconnect the power supply immediately and contact the dealer where you purchased the equipment, or Tsurumi's sales office in your area. If the pump continues to be used in the abnormal state, it may cause current leakage, electrical shock, or fire.

- (5) Proceed with the normal operation if no abnormal conditions are found during the trial operation.

Operation

WARNING

The pump unit may be extremely hot during operation. To prevent burns, do not touch the pump unit with bare hands during or after the operation.

Pay attention to the water level during the pump operation. The pump may become damaged if it is allowed to operate dry.

Due to an overload operation or a pump malfunction, if the motor protector trips to stop the pump, make sure to eliminate the cause of the problem before restarting.

To operate a submersible pump (including automatic operation), set the water level so that the pump will operate about 10 times per hour.

Note: A large amount of amperage flows when a submersible pump is started, causing the temperature of its windings to rise rapidly. Beware that a frequent stop-and-go operation of the pump will accelerate the deterioration of the insulation of the motor windings and thus affect the use life of the motor.

Operating Water Level

CAUTION

Do not operate the pump below the C.W.L. (Continuous Running Water Level) indicated below. Failure to observe this condition may result in damage to the pump, electrical leakage or electrical shock.

Pump Model	C.W.L. (mm)
LB-250	50
LBT-250	50
LB-480	50
LBT-480	50
LB-800	50
LBT-800	50

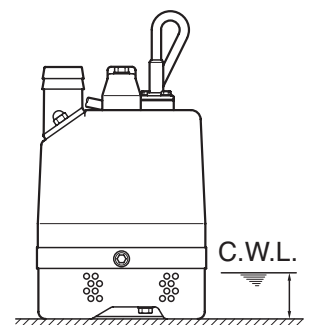

6-2 Automatic Operation (for float type LBZ-480 / 800)

Trial Operation

Equipped with floats to detect the water level the automatic type (LBZ) pump can perform an automatic drainage operation alone by merely connecting its cable to a power supply.

Connect the power and perform a trial operation as follows:

- (1) Direct all the floats downward.
- (2) Raise the (yellow) float. This will cause the pump to start.
- (3) Next, return the (yellow) float to their original positions. This will cause the pump to stop.
- (4) Perform steps (2) and (3) consecutively two or more times to verify the operation.

Note: *The trial operation (1) ~ (4) must be completed within 1 minute.*

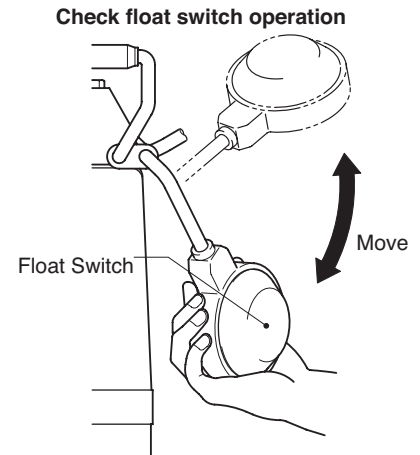

- (5) Conduct the trial operation (1) ~ (5) described in Section 6-1 NON-AUTOMATIC OPERATION

CAUTION In case the pump exhibits an abnormal condition (such as a considerable amount of vibration, noise, or smell), disconnect the power supply immediately and contact the dealer where you purchased the equipment, or Tsurumi's sales office in your area. If the pump continues to be used in the abnormal state, it may cause current leakage, electrical shock, or fire.

6-3 Automatic Operation (for electrode type LB-250A / 480A / 800A)

Operation Water Level

Start of the pump

The pump starts when the current continuously flows between the two electrodes for more than one (1) second.

Note: *The electrode may not detect the water surface under conditions such as purified water or distilled water which the current does not flow cause of high specific resistance.*

Note: *The necessary water level to operate the pump is 115mm or 170mm from the bottom of a pump. In case of start by racing during the trial operation, please short-circuit for more than one (1) second with exciting items (screw driver etc.) between the electrodes, and start forcibly. Please keep away from those that may clog in a pump.(wire, nail, cord, etc.)*

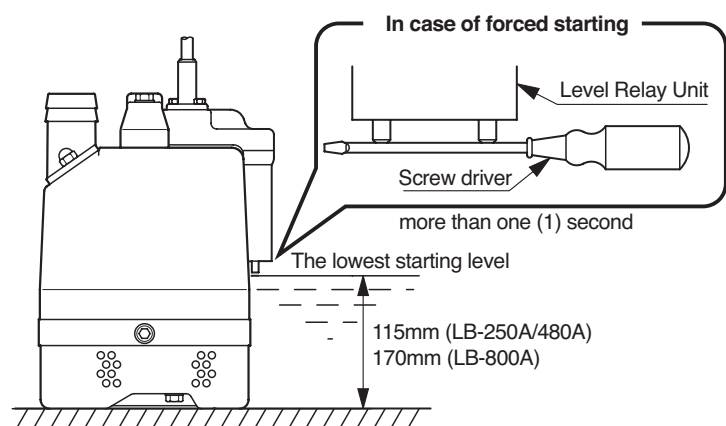

Trial Operation

WARNING Never start the pump while it is suspended, as the pump may jerk and cause a serious accident involving injury.

- (1) Operate the pump 3 to 10 minutes to verify the conditions listed below.

CAUTION In case the pump exhibits an abnormal condition (such as a considerable amount of vibration, noise, or smell), disconnect the power supply immediately and contact the dealer where you purchased the equipment, or Tsurumi's sales office in your area. If the pump continues to be used in the abnormal state, it may cause current leakage, electrical shock, or fire.

- (2) Proceed with the normal operation if no abnormal conditions are found during the trial operation.

Operation Flow Chart (LB-250A / 480A / 800A)

To enable the user to bring the pumps ability into full play, this chart describes the various control modes that are made possible by the combinations of the electrode and timer functions.

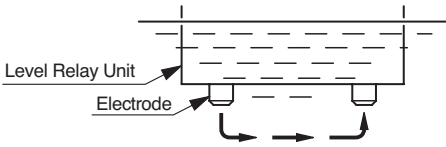
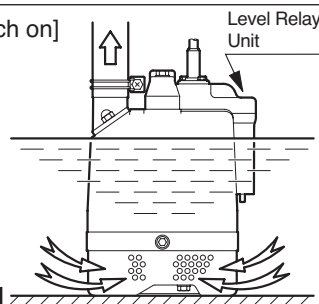
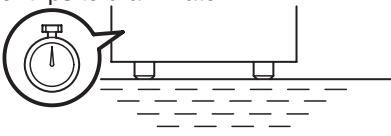
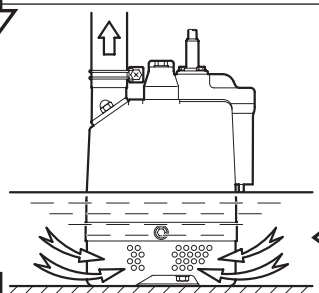
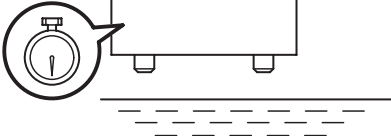
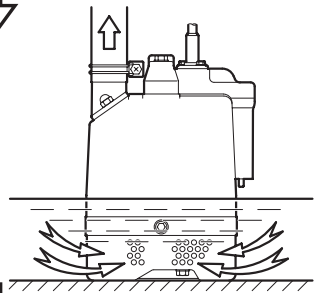
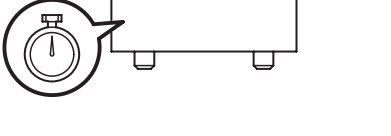
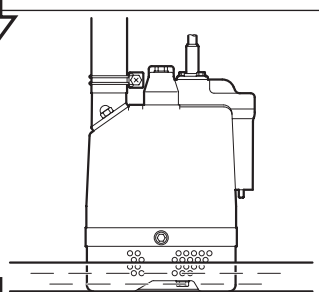
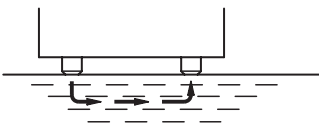
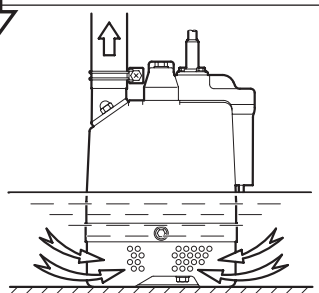
Level Relay Unit	Pump	Water Level	Condition
<p>The electrodes of the level relay unit are submerged, causing the current to operate the pump.</p>  <p>(Detection Time : more than one (1) second)</p>	Start Operation (Drainage)	Drop	<p>[Switch on]</p> 
<p>As the water level drops and the water surface recedes from the electrodes, the timer trips to drain water.</p>  <p>(Electrodes open Trips the timer)</p>	Operation (Drainage)	Drop	
<p>The draining of water by the timer lasts approximately 1 minute.</p> <p>※ If the water surface comes in contact with the electrodes within 1 minute, the pump will operate continuously even though the timer has tripped.</p> 	Operation (Drainage)	Drop	
<p>The pump will stop 1 minute later.</p>  <p>※ The pump will also stop after a continuous dry run, in some cases.</p>	Stop	Rise	
<p>When the water level rises and the water surface comes in contact for more than one (1) second with the electrodes, the pump will restart.</p>  <p>(Detection Time : more than one (1) second)</p>	Start Operation (Drainage)	Drop	

7 MAINTENANCE AND INSPECTION

Regular maintenance and inspection are indispensable to maintaining the pump's performance. If the pump behaves differently from its normal operating condition, refer to section "9. Troubleshooting" and take appropriate measures at an early stage. We also recommend that you have a spare pump on hand for an emergency.

Prior to Inspection

WARNING Make sure that the power supply (i.e. circuit breaker) is disconnected and disconnect the cable from the power outlet or remove it from the terminal board. Failure to do so may cause electrical shock or unintended starting of the pump, which may lead to serious accidents.

- (1) Washing the Pump
Remove any debris attached to the pump's outer surface, and wash the pump with tap water. Pay particular attention to the impeller area, and completely remove any debris from the impeller.
- (2) Inspecting the Pump Exterior
Verify that there is no damage, and that the bolts and nuts have not loosened.

Note: If the pump must be disassembled for repair due to damage or loose bolts or nuts, contact the dealer where it was purchased, or the Tsurumi sales office in your area.

Daily and Periodic Inspection

Interval	Inspection Item
Daily	Measuring the operating current ■ To be within the rated current Measuring the power voltage ■ Power supply voltage tolerance = within $\pm 5\%$ of the rated voltage
Monthly	Measuring the insulation resistance ■ Insulation resistance reference value = 1M Ω minimum [NOTE] The motor must be inspected if the insulation resistance is considerably lower than the last inspection.
Half-yearly	Inspecting oil ■ 1,000 hours or 6 months, whichever comes first. Inspection of lifting rope ■ Replace if damage, corrosion, or wear has occurred to the rope. Remove if foreign object is attaching to it.
Yearly	Changing oil ■ 2,000 hours or 12 months, whichever comes first. Changing the mechanical seal [NOTE] The inspection and replacement of the mechanical seal requires specialized equipment. To have this operation performed, contact the dealer where this equipment was purchased, or the Tsurumi sales office in your area.
Once every 2 to 5 years	Overhaul ■ The pump must be overhauled even if the pump appears normal during operation. Especially, the pump may need to be overhauled earlier if it is used continuously. [NOTE] To overhaul the pump, contact the dealer where it was purchased, or the Tsurumi sales office in your area.

Note: Refer to section "Oil Inspection and Change Procedures" below for further detail.

Storage

If the pump will not be operated for a long period of time, pull the pump up, wash the pump, allow it to dry, and store it indoors.

Note: For reinstallation, be sure to perform a trial operation before putting the pump into operation.

If the pump remains immersed in water, operate it on a regular basis (i.e. once a week).

Oil Inspection and Changing Procedures

Inspecting Oil

Remove the oil plug and take out a small amount of oil. The oil can be extracted easily by tilting the pump so that the oil filler plug faces downward. If the oil appears milky or intermixed with water, a likely cause is a defective shaft sealing device (i.e. mechanical seal), which requires that the pump be disassembled and repaired.

Changing Oil

Remove the oil plug and drain the oil completely. Pour a specified volume of oil into the oil filler inlet.

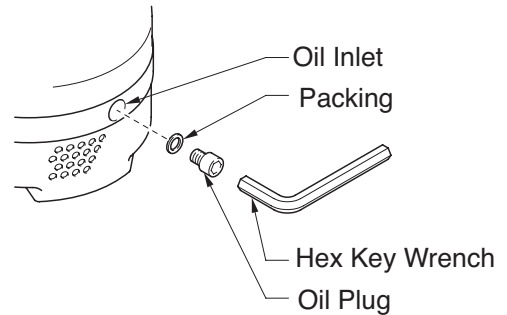

Specified Oil: Turbine Oil VG32 (non-additive)

Unit : ml

Pump Model	Specified Volume
LB-250, LBT-250, LB-250A	155
LB-480, LBT-480, LB-480A, LBZ-480	155
LB-800, LBT-800, LB-800A, LBZ-800	155

Note: The drained oil must be disposed of properly to prevent it from being released into the sewer or rivers. The packing or the O-ring for the oil plug must be replaced with a new part at each oil inspection and change.

Replacement Parts

The table lists the parts that need to be replaced periodically. Replace these using the recommended frequency as a guideline.

Part	Replacement condition
Mechanical Seal	When oil in oil compartment becomes milky.
Lubricant ; Turbine Oil VG 32 (non-additive)	Every 12 months or after 2,000 hours of use, whichever comes first.
Packing, O-Ring	Each time pump is disassembled or inspected
V-Ring	When ring is worn, and each time pump is disassembled or inspected
Shaft sleeve	When it becomes worn

8

DISASSEMBLY AND REASSEMBLY PROCEDURE

Prior to Disassembly and Reassembly



WARNING

Before disassembling and reassembling the pump, be sure that the power supply (i.e. circuit breaker) is disconnected, and remove the cabtyre cable from the outlet or the terminal board. Do not connect or disconnect the power plug with a wet hand, in order to prevent electrical shock. Do not perform an activation test (to check the rotation of the impeller) during disassembly and reassembly. Failure to observe this precaution could lead to a serious accident, including injury.

This section explains the disassembly and reassembly processes that are involved up to the replacement of the impeller itself. Operations involving the disassembly and reassembly of the sealing portion (i.e. mechanical seal) and of the motor require a specialized facility including vacuum and electrical test equipment. For these operations, contact the dealer where this equipment was purchased, or the Tsurumi sales office in your area.

Disassembly Procedure

- (1) Removing the strainer stand, suction cover, and the pump casing
Remove the hex bolts from under the strainer stand; then, remove the strainer stand, suction cover, and the pump casing from the pump body.
- (2) Removing the impeller
Using a box wrench, remove the impeller nut, spring washer and plain washer, then, remove the impeller, the shaft sleeve, and the v-ring from the shaft.
- (3) Removing the rear liner
Remove the rear liner from the oil casing.

Disassembly Diagram

Example

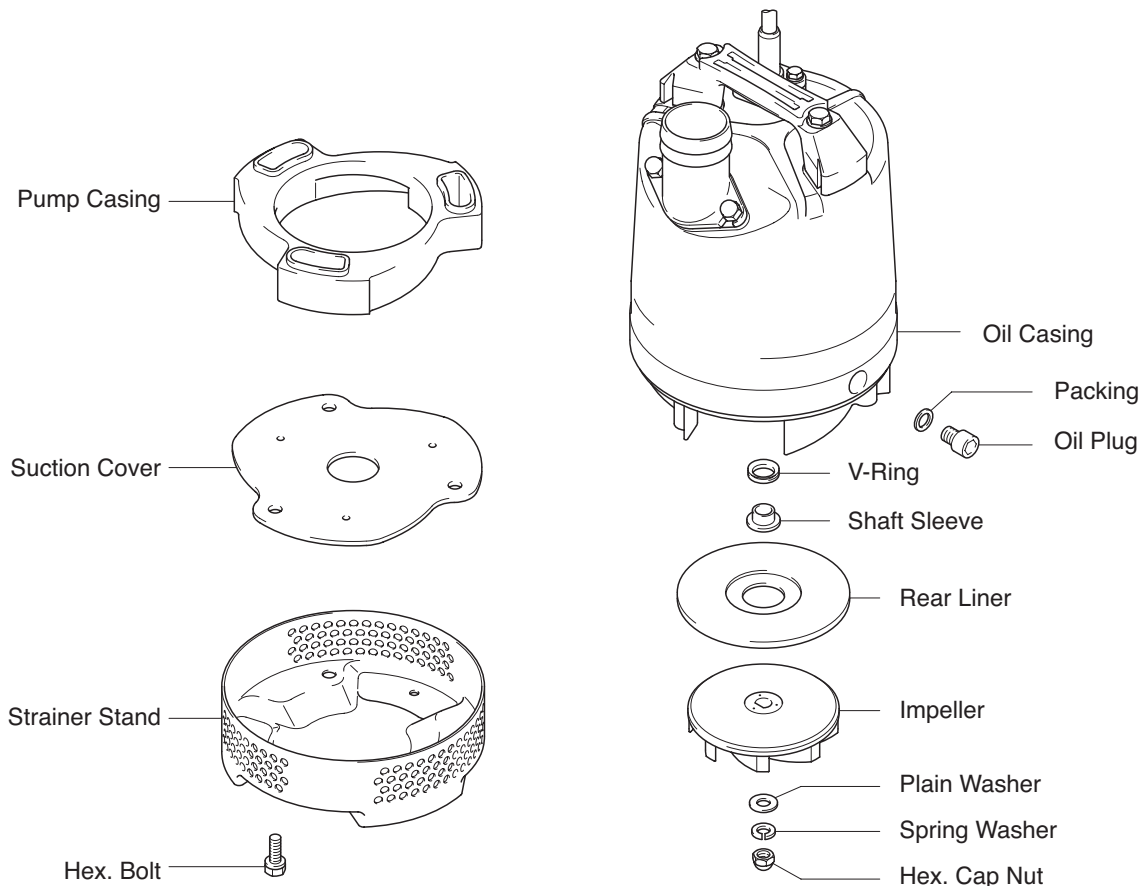

Reassembly Procedure

Observe the precautions given below and reassemble the unit in the reverse order of disassembly.

Note: *After completing the reassembly, make sure to fill the pump with the specified amount of oil. The packings must be replaced with a new part. If any part is worn or damaged, make sure to replace it with a new part.*

After reinstalling the impeller or the suction cover, check that the impeller rotates smoothly and that there is no interference between the pump casing and the suction cover.

Reassembling models

- (1) Assemble the rubber parts (rear face liner, impeller, and pump casing) after removing debris from them such as sand.
- (2) Mount the v-ring onto the outside of the shaft sleeve as shown in the drawing. When doing so, do not apply oil or other lubrication to the surface where the v-ring contacts the shaft sleeve.
- (3) When attaching the rear liner, make sure the front and back are oriented correctly, and press the liner firmly onto the surface.
- (4) After reinstalling the impeller or the suction cover, check that the impeller rotates smoothly and that there is no interference between it and the suction cover.

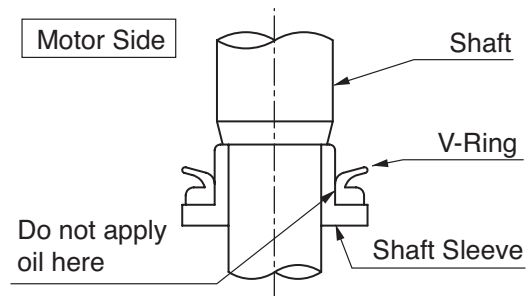

9 TROUBLESHOOTING

WARNING To prevent serious accidents, disconnect the power supply before inspecting the pump.

Read this Operation Manual carefully before requesting repair. After re-inspecting the pump, if it does not operate normally, contact the dealer where this equipment was purchased, or the Tsurumi sales office in your area.

Problem	Possible cause	Countermeasure
Pump fails to start; or, starts but stops immediately.	<ul style="list-style-type: none"> ① No proper power is supplied (i.e. power outage). ② Plug is not inserted. ③ Open circuit in cabtyre cable or poor connection. ④ Malfunction in float. ⑤ Electrode is insulated by debris. ⑥ Malfunction in level relay unit. 	<ul style="list-style-type: none"> ① Contact the electric power company or an electrical repair shop. ② Connect the plug. ③ Check whether there is an open circuit in the cabtyre cable or wiring. ④ Remove obstacles and check the operation of the float. ⑤ Use sandpaper to remove the debris. ⑥ Repair or replace the level relay unit.
Pump starts but stops immediately, causing the motor protector to trip.	<ul style="list-style-type: none"> ① Foreign matter is wedged in the impeller, causing the motor protector to trip. ② The movement of the stop float is obstructed, causing the start float alone to perform the start and stop operations. ③ The voltage is too low. ④ A 50Hz unit is used at 60Hz. ⑤ The pump has been operated for a long time with its strainer stand clogged. ⑥ Malfunction of motor (seizure or water leakage). ⑦ The pump is drawing in too much mud. 	<ul style="list-style-type: none"> ① Inspect the pump and remove the debris. ② Remove obstacles and check the operation of the stop float. ③ Provide the rated voltage or use an extension cable that meets the specifications. ④ Check the nameplate and replace the pump. ⑤ Remove the debris from the strainer stand. ⑥ Repair or replace. ⑦ Place a concrete block under the pump to prevent the pump from drawing in excess mud.
The pumping volume is low.	<ul style="list-style-type: none"> ① The impeller is worn. ② The hose is clogged or kinked at its midspan. ③ The strainer stand is clogged or is buried. ④ The motor rotates in reverse. ⑤ A 60Hz pump is used at 50Hz. 	<ul style="list-style-type: none"> ① Replace the impeller. ② Minimize the bends of the hose, and if the pump is used in a dusty area, place it inside a mesh basket during operation. ③ Remove the debris from the strainer stand. Place a concrete block under the pump to prevent the pump from drawing in excess mud. ④ Change the power connection. ⑤ Check the nameplate and replace the pump.
Pump generates vibration or noise.	<ul style="list-style-type: none"> ① Motor bearings are damaged. 	<ul style="list-style-type: none"> ① Replace the bearings.
The pump does not stop automatically.	<ul style="list-style-type: none"> ① The movement of the floats is obstructed. The switch in a float is faulty. ② The water level of the (stop) float is set lower than the pump's minimum possible operating water level. ③ Malfunction in level relay unit ④ Electrode is shorted by debris. ⑤ Influence by electrical device in the vicinity of the pump. 	<ul style="list-style-type: none"> ① Remove the blockage. Or, replace the part. ② Set the water level of the (stop) float higher than the pump's minimum possible operating water level. ③ Repair or replace the level relay unit. ④ Use sandpaper to remove the debris. ⑤ Check whether there are any wires that are tangled around the electrode. Check whether there are any electrical devices that could generate electro-magnetic interference, and relocate the unit as necessary.

The following information is required when ordering repairs or making other inquiries.

Product model	
Manufacturing number	
Purchase date	
Remarks	

Disposal of Product

Properly dispose of the product by disassembling it, presorting the contents, and sending them to the waste material treatment site.

©2020 TSURUMI MANUFACTURING CO., LTD.