



B.A.R. Group Pty Ltd

15 Hudson Place, Mulgrave, NSW 2756

Phone: +61 2 4577 2144; Fax: +61 2 4577 3184

Email: sales@bargroup.com.au

DIESEL PRESSURE CLEANERS

GENERAL USER MANUAL

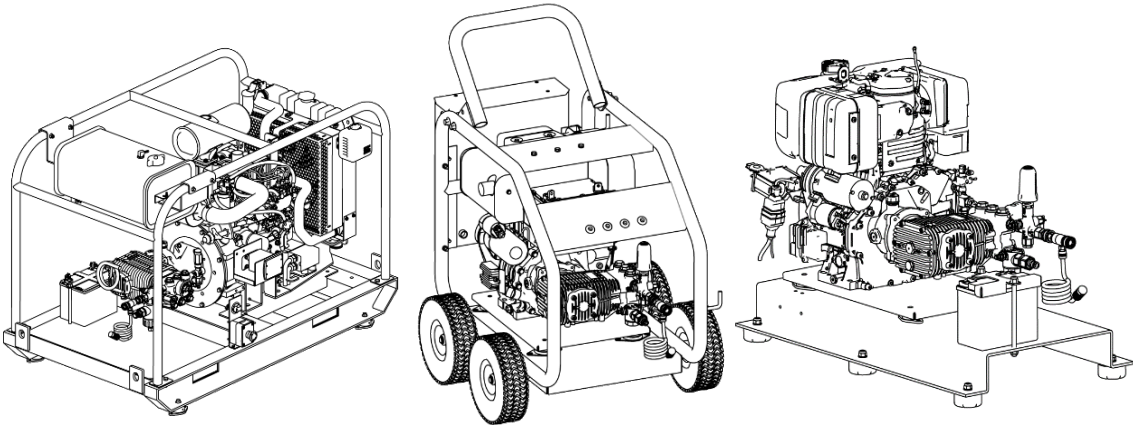

FOLLOW US ON



www.bargroup.au



Introduction

Using the Operators Manual 4

Product Identification

Product Identification Numbers 5

Lubrication Chart..... 5

Safety

Safety Rules 6

Cooling Information..... 7

Hazard Symbols and Meanings..... 8

Pressure Cleaner Components

Components Identification..... 14

Assembly

Unpack the Pressure Washer 16

Attach Handle..... 16

Pre-Operation Checklist

Check Oils, Fuel, Water..... 17

Connect Hose and Water Supply to Pump 17

Starting Your Cleaner

How to Start your Pressure Cleaner 18

Shutting Down Your Cleaner

How to Shut Down your Pressure Cleaner..... 22

Spray Tips

How to Use Spray Tips23

Change Spray Tips23

Usage Tips23

Using The Black Soap Nozzle

Applying Detergent.....24

Troubleshooting

Diesel Engine Trouble Shooting Chart.....25

Pump Trouble Shooting Chart.....26



Storage

Winter Storage27
Long Term Storage27
Protect Fuel System27
Storing the Engine28
Other Storage Tips28

Terms And Conditions

Terms and Conditions.....29
Warranty Statement.....30

Notes

Maintenance Notes.....31



Attention: Read through the complete manual prior to the initial use of your pressure washer.

Using the Operator's manual

The operating manual is an important part of your pressure washer. It should be read thoroughly before initial use, and referred to often to make sure adequate safety and service concerns are being addressed.

Reading the owner's manual thoroughly will help avoid any personal injury or damage to your machine. By knowing how best to operate this machine, you will be better positioned to show others who may also operate the unit.

This manual was written to take you from the safety requirements to the operating functions of your machine. You can refer back to the manual at any time to help troubleshoot any specific operating functions, so store it with the machine at all times.

Notice

Actual pressure released at the point of discharge may vary by machine due to varying factors including Volume of water being fed to the machine by the water source, the inclusion of a Chemical injector in the line, or variations in Engine performance.

[NOTE: This is a general manual. For your specific model, contact your BAR authorized dealer.]

If you need to contact an Authorized Dealer or Customer Service line (02 4577 2144) for information on servicing, always provide the product model and identification numbers.

You will need to locate the model and serial number for the machine and record the information in the places provided below.

Date of Purchase:
Dealer Name:
Dealer Phone:

Product Identification Numbers
Model Number:
Serial Number:

Lubrication Chart	
Pump:	Universal Tractor Transmission Oil
Engine:	SAE 15W40 Diesel Oil
Gearbox:	SAE 90

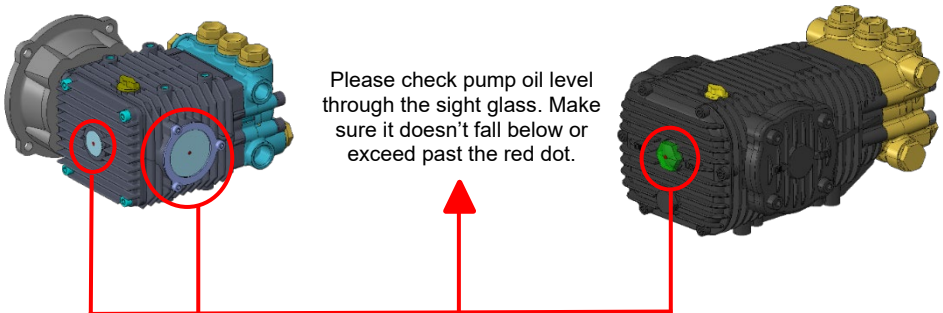

IMPORTANT SAFETY INSTRUCTIONS

SAVE THESE INSTRUCTIONS

WARNING - When using this product, the following precautions should always be observed and adhered to.

1. Read all instructions before using the product.
2. To reduce the risk of injury, close supervision is necessary when a product is used near children.
3. Know how to stop the product and bleed pressures quickly. Be thoroughly familiar with the controls. See **page 22**.
4. Stay alert - watch what you are doing.
5. Do not operate the product when fatigued or under the influence of alcohol or drugs.
6. Keep operating area clear of other people.
7. Do not overreach or stand on unstable support. Keep solid footing and balance at all times.
8. Follow the maintenance instructions specified in the manual.

Important Warnings

Failure to observe warnings will void warranty and/or cause injury.

1. Do not let the pressure washer overheat. Excess heat will cause severe damage (see below for details).
2. Never run the unit without water. Running the pump dry will cause it to quickly fail (**NOT COVERED BY WARRANTY**).
3. Do not let the unit freeze. Frozen water in the pump will cause serious damage.
4. Always wear eye protection when operating the unit.
5. High pressure spray can cause serious bodily injury or damage soft material. Use with caution.
6. Never adjust unloader to exceed the preset pressure. Premature wear, equipment failure, or injury may occur.

Motors are air cooled. It is important to ensure that machine is operated in a well-ventilated area where it can draw a steady supply of fresh air. The arrows below show an example of locations for air intake on an engine.

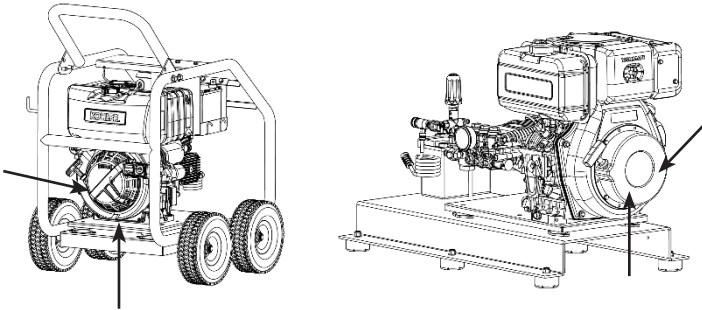

Pumps are water cooled. When the machine is running, ensure the trigger of the gun is pressed to allow a constant flow of fresh water into and out of the pump. **Do not let the machine run for more than 30 seconds without pressing down on the trigger.**

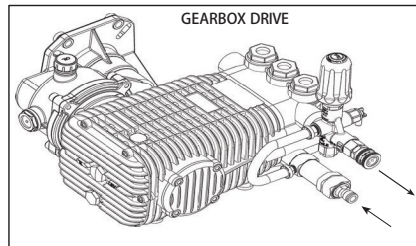
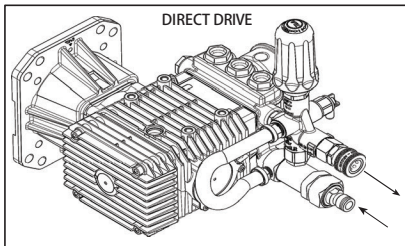

Most pumps are protected by a **thermal valve**. The thermal valve releases water if a pump starts to run too hot. It will prevent catastrophic heat failure. However, the pump may have suffered damage and need maintenance, repair, or replacement. If it does not reset and continues to leak water, the thermal valve may need to be replaced.

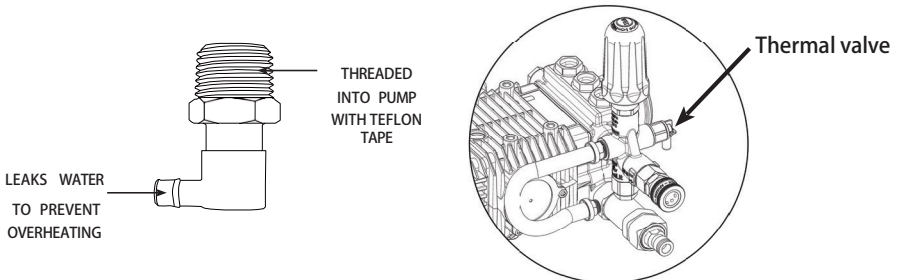

SAVE THESE INSTRUCTIONS**Safety Rules**

This is the safety alert symbol. It is used to alert you to potential personal injury hazards. Obey all safety messages that follow this symbol to avoid possible injury or death.

The safety alert symbol () is used with a signal word (DANGER, CAUTION, WARNING), a pictorial and/or a safety message to alert you to hazards.













DANGER indicates a hazard which, if not avoided, will result in death or serious injury.

WARNING indicates a hazard which, if not avoided, could result in death or serious injury.

CAUTION indicates a hazard which, if not avoided, might result in minor or moderate injury.

NOTICE indicates a situation that could result in equipment or property damage.

Hazard Symbols and Meanings

			
EXPLOSION	FIRE	ELECTRIC SHOCK	TOXIC FUMES
			
KICKBACK	HOT SURFACE	FLYING OBJECTS	SLIPPERY
			
FALL	FLUID INJECTION	MOVING PARTS	READ MANUAL

 **WARNING**

Fuel and its vapors are extremely flammable and explosive.



Fire or explosion can cause severe burns or death.

When Adding or Draining Fuel

- Turn pressure cleaner OFF and let it cool at least 2 minutes before removing fuel cap. Loosen cap slowly to relieve pressure in tank.
- Fill or drain fuel tank outdoors and in accordance with the LOCAL GOVERNMENT GUIDELINES.
- DO NOT overfill tank. Always allow space for fuel expansion.
- If fuel spills, wait until it evaporates before starting engine.
- Keep fuel away from sparks, open flames, pilot lights, heat, and other ignition sources.
- DO NOT light a cigarette or smoke.

When Starting Equipment

- Ensure muffler, fuel cap, and air cleaner are in place.

When Operating Equipment

- DO NOT tip engine or equipment at angle which causes fuel to spill.
- DO NOT spray flammable liquids.

When Transporting or Repairing Equipment



- Transport/repair with fuel tank EMPTY or with fuel shutoff valve OFF.



When Storing Fuel or Equipment with Fuel in Tank



- Store away from furnaces, stoves, water heaters, clothes dryers, or other appliances that have pilot light or other ignition source because they can ignite fuel vapors.

**WARNING**

This product can expose you to chemicals including lead, which is known to cause cancer and birth defects or other reproductive harm. Wash hands after handling.

 WARNING	
	<p>A running engine gives off carbon monoxide, an odorless, colorless, poison gas.</p> <p>Breathing carbon monoxide can cause headache, fatigue, dizziness, vomiting, confusion, seizures, nausea, fainting or death. Some chemicals or detergents may be harmful if inhaled or ingested, causing severe nausea, fainting, or poisoning.</p>
<ul style="list-style-type: none">• Operate pressure cleaner ONLY outdoors.• Keep exhaust gas from entering a confined area through windows, doors, ventilation intakes, or other openings.• DO NOT start or run engine indoors or in an enclosed area, even if windows and are open.• Use a respirator or mask whenever there is a chance that vapors may be inhaled.• Read all instructions with mask so you are certain the mask will provide the necessary protection against harmful vapors.	

 WARNING	
	<p>Starter cord kickback (rapid retraction) can result in bodily injury. Kickback will pull hand and arm toward engine faster than you can let go.</p> <p>Broken bones, fractures, bruises, or sprains could result.</p>
<ul style="list-style-type: none">• NEVER pull starter cord without first relieving spray gun pressure.• When starting engine, pull cord slowly until resistance is felt and then pull rapidly to avoid kickback.• After each starting attempt, where engine fails to run, always point spray gun in safe direction and squeeze spray gun trigger to release pressure.• Firmly grasp spray gun with both hands when using high pressure spray to avoid injury when spray gun kicks back.	

 WARNING	
	<p>Risk of electrocution.</p> <p>Contact with power source can cause electric shock or burn.</p>
<ul style="list-style-type: none">• NEVER spray near a power source.	

⚠ WARNING



Use of pressure cleaner can create puddles and slippery surfaces.



Kickback from spray gun can cause you to fall.

- Operate pressure cleaner from a stable surface.
- The cleaning area should have adequate slopes and drainage to reduce the possibility of a fall due to slippery surfaces.
- Be extremely careful if you must use the pressure washer from a ladder, scaffolding, or any other similar location.
- Firmly grasp spray gun with both hands when using high pressure spray to avoid injury when spray gun kicks back.

⚠ WARNING



Contact with muffler area can result in serious burns.



Exhaust heat/gases can ignite combustibles, structures or damage fuel tank causing a fire.

- DO NOT touch hot parts and AVOID hot exhaust gases.
- Allow equipment to cool before touching.
- Keep at least 5 feet (1.5 m) of clearance on all sides of pressure cleaner including overhead.

⚠ WARNING



Risk of eye injury.

Spray can splash back or propel objects.

- Always wear safety goggles when using this equipment or in vicinity of where equipment is in use.
- Before starting the pressure cleaner, be sure you are wearing adequate safety goggles.
- NEVER substitute safety glasses for safety goggles.

⚠ WARNING

The high pressure stream of water that this equipment produces can cut through skin and its underlying tissues, leading to serious injury and possible amputation.

Spray gun traps high water pressure, even when engine is stopped and water is disconnected, which can cause injury.

- DO NOT allow children to operate the pressure cleaner.
- NEVER repair the high pressure hose. Replace it.
- NEVER repair leaking connections with sealant of any kind. Replace o-ring or seal.
- NEVER connect high pressure hose to nozzle extension.
- Keep high pressure hose connected to pump and spray gun while system is pressurized.
- ALWAYS point spray gun in safe direction and squeeze spray gun trigger to release high pressure every time you stop engine.
- NEVER aim spray gun at people, animals, or plants.
- DO NOT leave spray gun unattended while machine is running.
- NEVER use a spray gun which does not have a trigger lock or trigger guard in place and in working order.
- Always be certain spray gun, nozzles and accessories are correctly attached before spraying water.

⚠ WARNING

Starter and other rotating parts can entangle hands, hair, clothing, or accessories.

- NEVER operate pressure cleaner without protective housing or covers.
- DO NOT wear loose clothing, jewelry or anything that may be caught in the starter or other rotating parts.
- Tie up long hair and remove jewelry.

WARNING



Unintentional sparking can result in fire or electric shock.

When Adjusting or making Repairs to Your Pressure Washer Cleaner

- Disconnect the spark plug wire from the spark plug and place the wire where it cannot contact spark plug.

When Testing for Engine Spark

- Use approved spark plug tester.
- DO NOT check for spark with spark plug removed.

NOTICE

High pressure spray may damage fragile items including glass.

- DO NOT point spray gun at glass when using red 0° spray tip.
- NEVER aim spray gun at plants, animals or any other living thing.

NOTICE

Improper treatment of pressure washer can damage it and shorten its life.

- If you have questions about intended use, contact your nearest authorized dealer, call our support line, or visit our website.
- NEVER operate units with broken or missing parts, or without protective housing or covers.
- DO NOT by-pass any safety device on this machine.
- DO NOT tamper with governed speed.
- DO NOT operate pressure cleaner above rated pressure.
- DO NOT modify pressure cleaner in any way.
- Before starting pressure cleaner in cold weather, check all parts of the equipment to be sure ice has not formed.
- NEVER move machine by pulling on hoses. Use the handle provided on unit's frame.
- Check fuel system for leaks or signs of deterioration, such as chafed or spongy hose, loose or missing clamps, and damaged tank or cap.
- Correct all defects before operating pressure cleaner.

The following diagram is intended for general reference.

Your pressure cleaner may differ from the model shown below. For specific model information, please visit www.bargroup.com.au.

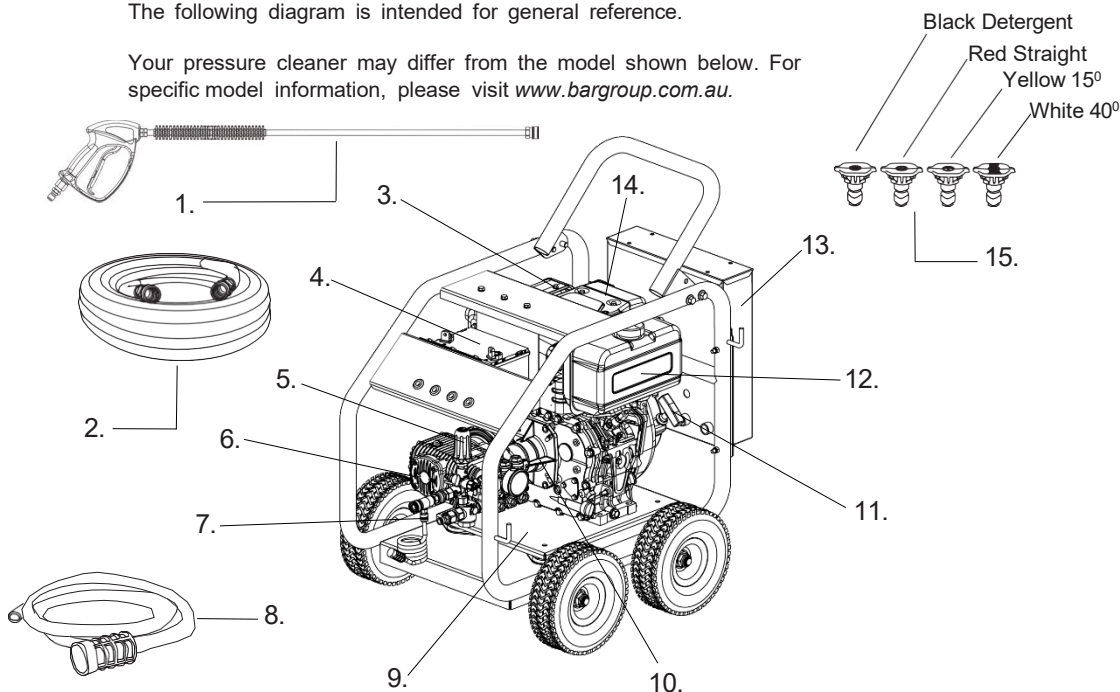

1. **Spray Gun/Lance Assembly** - Controls the application of water onto cleaning surface with trigger device. Includes trigger lock. Allows you to switch between various spray tips.
2. **High Pressure Hose** - Designed to withstand the pressure created by the pump.
3. **Muffler/Exhaust** - Reduces noise of the engine and expels heat (CAUTION HOT).
4. **Battery** - For electric start machines.
5. **Unloader** - Pressure is preset at the factory.
6. **Pump** - Develops high pressure. Connect the garden hose to the water tank as this feeds water to the pump and connect the high pressure hose to the outlet.
7. **Detergent Pick Up** - Low pressure chemical pick up.
8. **Detergent Siphoning Hose** - Used to draw detergent into the low pressure stream.
9. **Vibration Plate** - Connects pump motor group to frame via anti-vibration mounts.
10. **Gearbox** - Reduces engine speed to 1440 rpm (slow running of pump).
11. **Recoil Starter** - Used for starting the engine manually.
12. **Fuel Tank** - Fill tank with regular diesel. Always leave room for fuel expansion. Do not fill while machine is running or hot.
13. **Water Tank** - Holds water in reserve for pump supply (must be FULL before you start operating).
14. **Air Filter** - Protects the engine by filtering dust and debris out of intake air.
15. **Spray Tips** - Detergent, 0°, 15°, and 40°: for various cleaning applications.

[NOTE: Tank units are fitted with low water cut out and must be FULL to use.

See Diesel engine manual also provided for detailed operation/maintenance & warranty information.]

The following diagram is intended for general reference.

Your pressure cleaner may differ from the model shown below. For specific model information, please visit www.bargroup.com.au.

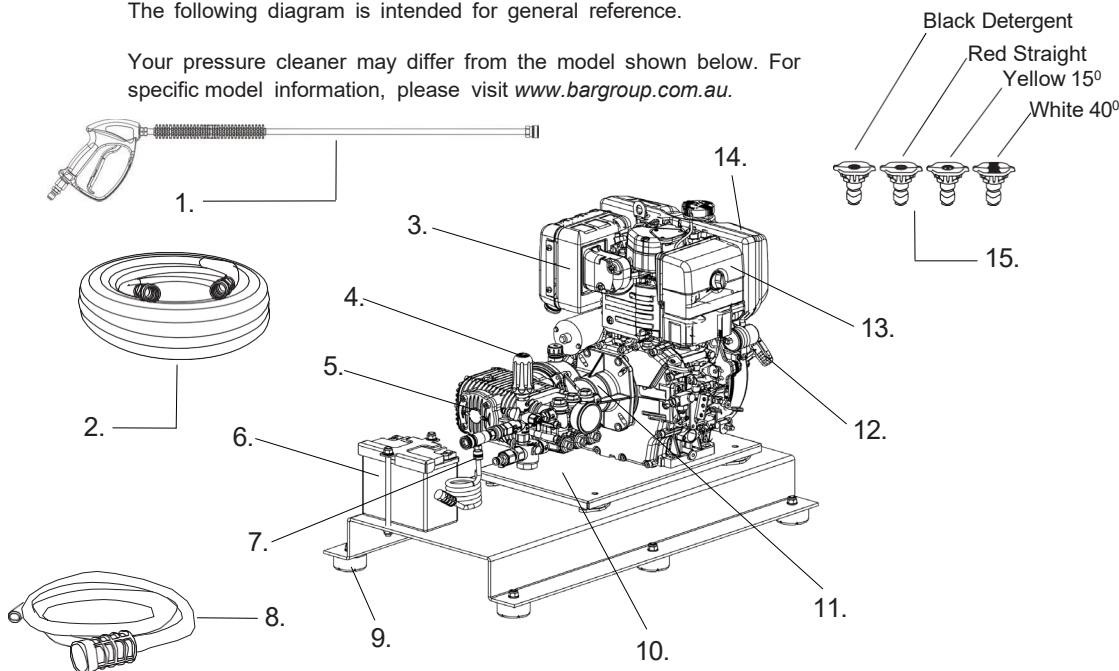

1. **Spray Gun/Lance Assembly** - Controls the application of water onto cleaning surface with trigger device. Includes trigger lock. Allows you to switch between various spray tips.
2. **High Pressure Hose** - Designed to withstand the pressure created by the pump.
3. **Muffler/Exhaust** - Reduces noise of the engine and expels heat (CAUTION HOT).
4. **Unloader** - Pressure is preset at the factory.
5. **Pump** - Develops high pressure. Connect the garden hose to the water tank as this feeds water to the pump and connect the high pressure hose to the outlet.
6. **Battery** - For electric start machines.
7. **Detergent Pick Up** - Low pressure chemical pick up.
8. **Detergent Siphoning Hose** - Used to draw detergent into the low pressure stream.
9. **Rubber mounts** - isolates motor pump group via rubber feet.
10. **Vibration Plate** - Connects pump motor group to frame via anti-vibration mounts.
11. **Gearbox** - Reduces engine speed to 1440 rpm (slow running of pump).
12. **Recoil Starter** - Used for starting the engine manually.
13. **Air Filter** - Protects the engine by filtering dust and debris out of intake air.
14. **Fuel Tank** - Fill tank with regular diesel. Always leave room for fuel expansion. Do not fill while machine is running or hot.
15. **Spray Tips** - Detergent, 0°, 15°, and 40° : for various cleaning applications.

[NOTE: See Diesel engine manual also provided for detailed operation/maintenance & warranty information.]

Your pressure cleaner requires some assembly and is ready for use after it has been properly serviced with the recommended oil and fuel. We recommend **SAE 15W40** Diesel Oil for engines. **SAE 90** Gear Oil for gearbox units and **Universal Tractor Transmission Oil** for pump. See page 5.

If you have any problems with the assembly of your pressure cleaner, please call our support line. If calling for assistance, please have the model and serial number from the data tag available.

Unpack the Pressure Cleaner

1. Remove the parts bag, accessories, and inserts included with pressure cleaner.
2. Open box completely by cutting each corner from top to bottom.
3. Ensure all contents are present prior to assembly.

Attach Handle

1. Place handle (A) onto frame tube (B) connected to main unit.
Make sure holes in handle align with holes on handle supports.

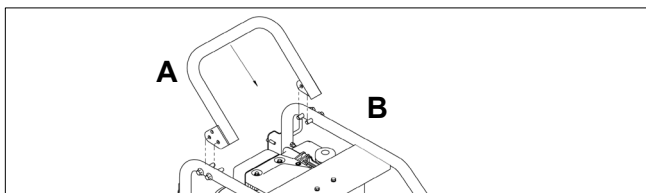

NOTE: These diagrams are intended for general reference. As a result, they may not fully reflect the appearance of your product.

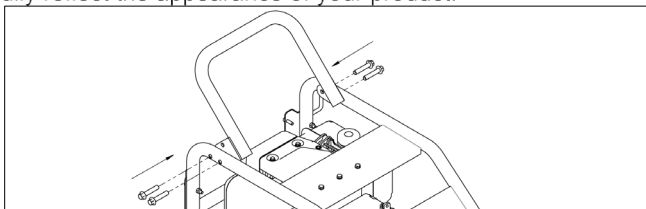

2. Insert carriage bolts through holes from inside of unit and attach nuts from outside of unit. Tighten using spanner.
3. Insert multi-colored quick connect spray tips and other supplied accessories in spaces provided on panel.

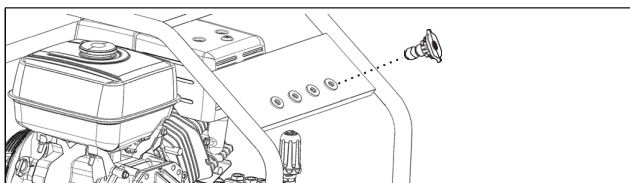



Follow the steps below prior to using the machine every time.



1. Check to ensure the engine oil is at the proper level. **Use SAE 15W40 Diesel Oil.**
2. Check the handle in the frame to ensure they are tight and will not vibrate loose.
3. Add **DIESEL** to the fuel tank. Be careful not to spill while filling and do not overfill.
4. Connect and tighten the garden hose to the GHA (garden hose inlet) connection.
5. Connect high pressure hose to the pump outlet. Connect the other end to the spray gun.

****Water must be turned on prior to starting the cleaner, pull the spray trigger to ensure water is moving through the lines and out the nozzle without any leaks before starting the unit. Tank units will not flow water until started. Tank must be full before starting.****

6. Review the safety guidelines in the manual prior to starting the unit. If you have any issues operating the pressure cleaner, call our customer service line.

 WARNING	
 oil	Always check the level of the engine oil prior to starting the cleaner. Oil level of the pump/gearbox should be at about halfway up the sight glass. If your unit does not have one, use the oil dipstick. The level should be about halfway up the dipstick.
<ul style="list-style-type: none">• Failure to do so could cause the engine to seize if the oil is low or empty.	

Connect Hose and Water Supply to Pump Before Starting

 WARNING	
	DO NOT start your pressure cleaner without the water supply turned on.
<ul style="list-style-type: none">• Failure to do so will result in damaging the pump from overheating and void the warranty.	

How to Start Your Pressure Cleaner

To start your pressure cleaner for the first time, follow these instructions step-by-step. This starting information also applies if you have let the pressure cleaner sit idle for at least a day.

1. Place pressure cleaner near an outside water source capable of supplying water at a flow rate of at least 1GPM greater than the rated flow of your pressure cleaner. It should also be no less than 20 PSI at pressure cleaner end of garden hose. DO NOT siphon standing water.
2. Make sure unit is in a level position and apply handbrake (if fitted) or "chock" wheels as needed.
3. Connect garden hose to water inlet on pressure cleaner pump or tank.

NOTICE

DO NOT run the pump without the water supply connected and turned on.

- Damage to equipment resulting from failure to follow this instruction will void warranty.

4. Choose desired spray tip, pull back nozzle extension collar, insert spray tip and release collar. Tug on spray tip to make sure it is securely in place. See *Spray Tips*.

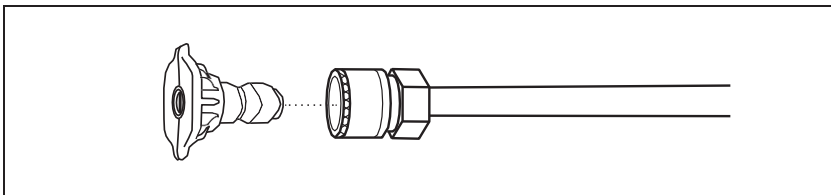

5. If your gun uses a quick-connect, pull down on the collar of the quick connect coupler, slide onto the gun and let go of collar. Pull on hose to ensure the connection is tight. If your gun uses an M22 fitting, simply thread the connections together until secure.

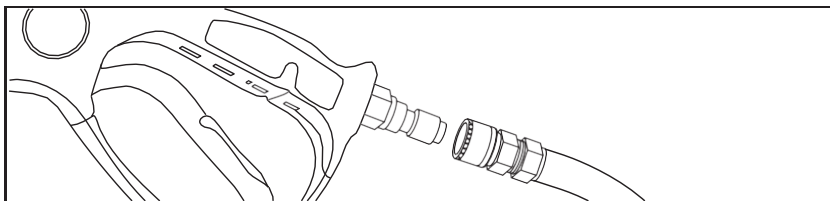
**⚠ WARNING**

The high pressure stream of water that this equipment produces can cut through skin and its underlying tissues, leading to serious injury and possible amputation.

- NEVER connect high pressure hose directly to nozzle extension.
- Keep high pressure hose connected to pump and spray gun while system is pressurized.

6. Attach the other end of the high pressure hose to high pressure outlet (A) on pump. Pull down on collar of quick connect, slide onto pump and let go of collar. Note that some pumps require the hose to be threaded on. Tug on the hose to ensure connection is secure.

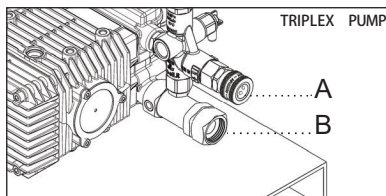
***Pump Uses SAE30 Non-Detergent Mineral Oil**

7. Turn Water Supply on if you have not already done so. Point the gun in a safe direction and squeeze the trigger to purge the pump of air and debris. Do this until water flow is no longer erratic. Tank units will not flow water until started.
8. Take a final look at all connections to make sure there are no leaks or loose connections. If there are any leaks in hoses, they must be replaced.

IMPORTANT: DO NOT siphon standing water for the water supply.



Use COLD WATER only (less than 100°F/38°C). Hot water will damage seals and compromise the integrity of your pump.





9. To start the machine, locate the engine switch/knob on the side of the engine (if applicable), and switch it to the ON position.
10. Brace the unit with your foot and ensure that you are completely balanced on a flat surface. Pull recoil cord slowly until resistance is felt and then pull rapidly to avoid kickback. DO NOT place hand on engine muffler for balance as this will result in a severe burn. *[If key-start switch is available, turn the key to "START" position and hold it until it starts.]*

For more information on engine start-up, see manual provided with your machine.

[NOTE: Should the engine not start after 2-3 attempts, open trigger gun to release pressure build-up and then try again to start engine.]

 WARNING	
	<p>A running engine produces carbon monoxide, an odorless, colorless, poison gas.</p> <p>Breathing carbon monoxide can cause headaches, fatigue, dizziness, vomiting, confusion, seizures, nausea, fainting, and death.</p>
<ul style="list-style-type: none">• Operate pressure cleaner outdoors, never indoors.• Keep exhaust gas from entering a confined area through windows, doors, ventilation intakes, or other openings.• DO NOT start or run engine indoors or in an enclosed area, even if windows and doors are open.	

IMPORTANT: Before starting the pressure cleaner, ensure you are wearing adequate safety goggles.



 WARNING	
	<p>Risk of eye injury.</p> <p>Spray can splash back or propel objects such as rocks, dirt and other debris.</p>
<ul style="list-style-type: none">• Always wear safety goggles when using this equipment or while in vicinity of where equipment is in use.• NEVER substitute normal glasses for safety goggles.	

⚠ WARNING

The high pressure stream of water that this equipment produces can cut through skin and its underlying tissues, leading to serious injury and possible amputation.

Spray gun traps high water pressure, even when engine is stopped and water is disconnected, which can cause injury.

- DO NOT allow CHILDREN to operate pressure cleaner.
- NEVER repair high pressure hose. Replace it.
- NEVER repair leaking connections with sealant of any kind. Replace the o-ring or seal.
- NEVER connect high pressure hose directly to the spray nozzle.
- Keep high pressure hose connected to pump and spray gun while system is pressurized.
- ALWAYS point spray gun in safe direction and squeeze spray gun trigger, to release high pressure, every time you stop engine.
- NEVER aim spray gun at people, animals, or plants.
- DO NOT secure spray gun in open position.
- DO NOT leave spray gun unattended while machine is running.
- NEVER use a spray gun which does not have a trigger lock or trigger guard in place and in working order.
- ALWAYS be certain spray gun, nozzles and accessories are correctly attached. Failure to do so can result in damage to the unit or bodily harm.

 WARNING	
 	<p>Contact with muffler area can result in serious burns.</p> <p>Exhaust heat/gases can ignite combustibles, structures or damage fuel tank causing a fire.</p>
<ul style="list-style-type: none">• DO NOT touch hot parts and avoid hot exhaust gases.• Allow equipment to cool for at least 15 minutes before touching.• Keep at least 5 feet (1.5 m) of clearance on all sides of pressure cleaner (including overhead) while in operation.	

How to Shut Your Pressure Cleaner Down

1. Release spray gun trigger and let engine idle down. See engine manual provided.
2. Turn the engine switch/knob to the OFF/STOP position.
3. ALWAYS point spray gun in a safe direction, squeeze spray gun trigger to release retained high water pressure.
4. Disconnect all hoses and guns and remove any held water before storage.

IMPORTANT: Spray gun traps high water pressure, even when engine is stopped and water is disconnected. Couplers will not release if under pressure.

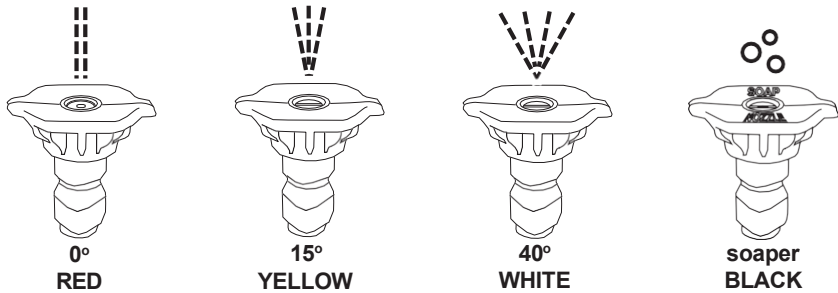

How to Use Spray Tips

The quick-connect on the nozzle extension allows you to switch between four different quick connect spray tips. Spray tips can be changed while the pressure cleaner is running once the spray gun trigger safety lock is engaged. The spray tips vary the spray pattern as shown above.

Follow these instructions to change spray tips:

1. Pull back collar on quick-connect coupler and pull the current spray tip off. Store the spray tips in the holder provided on the handle. Storing nozzles in the designated holder will help prevent any debris from clogging the tip.
2. Select the desired spray tip:
 - For a gentle rinse, select the white 40° spray tip.
 - For high pressure cleaning, select the yellow 15° spray tip.
 - To scour the surface, select the red 0° spray tip.
 - To apply detergent, select the black spray tip.
3. Pull back on collar, insert new spray tip and release collar. Tug on spray tip to make sure it is securely in place.

Usage Tips

- For most effective cleaning, keep spray tip 8 to 24 inches away from cleaning surface.
- If you get spray tip too close, especially using a high pressure spray tip (red or yellow), you may damage the surface being cleaned. **Do not use the red spray tip on glass.**



USING THE BLACK SOAP NOZZLE

To apply detergent, follow these steps:

1. Review the use of spray tips.
2. Prepare detergent solution as required by the job. See your BAR shop for detergent options.
3. Place the small filter end of detergent siphoning tube into detergent container or on-board soap tank (if applicable).
4. Connect the other end of the soap hose to the pressure cleaner low pressure detergent injector.

NOTE: Make sure the filter is fully submerged in detergent during use.

5. Ensure that the black spray tip is installed.
 - . Make sure the garden hose is connected to the water inlet. Check that the high pressure hose is connected to spray gun and pump. Turn water on.

Please note that only the BLACK NOZZLE will draw soap.

NOTICE

You must attach all hoses before you start the engine.

- Starting the engine without all the hoses connected and without the water turned ON will damage the pump.
- Damage to equipment resulting from failure to follow this instruction is not covered by warranty.

7. Start the engine following instructions in *Starting Your Cleaner*.
8. Apply the detergent to the surface using long, even, overlapping strokes.
9. Allow the detergent to "soak in" before washing and rinsing. See instructions on chemical for best procedure.

Reapply as needed to prevent surface from drying. **DO NOT allow detergent to dry on.** This will damage paint clear coat, and other types of finish.

IMPORTANT: You must flush the detergent siphoning system after each use by placing the filter into a bucket of clean water and running the pressure cleaner at low pressure for 1-2 minutes.

CAUTION

Chemicals can cause bodily harm and/or property damage.

- NEVER use caustic liquid or acid with pressure cleaner.
- Use ONLY pressure cleaner safe detergent/soaps. Follow all manufacturer instructions and do not mix detergents with other types.



Troubleshooting Chart

If you are experiencing an issue that is not listed in this chart and respective manuals provided or have checked all the possible causes listed and are still experiencing the problem, see your authorized dealer or call our support line.

DIESEL ENGINES

Problem	Cause	Correction
Unit has following problems: failure to produce pressure, erratic pressure, chattering, loss of pressure, low water volume.	<ol style="list-style-type: none"> 1. Low pressure spray tip installed. 2. Water inlet is blocked. 3. Inadequate water supply. 4. Inlet hose is kinked or leaking. 5. Clogged inlet hose screen. 6. Water supply is over 100°F (38°C). 7. High pressure hose is blocked or leaks. 8. Spray gun leaks. 9. Spray tip is obstructed. 10. Pump is faulty. 	<ol style="list-style-type: none"> 1. Replace with high pressure spray tip. 2. Clear inlet. 3. Provide adequate water flow. 4. Straighten inlet hose. Replace if leaking. 5. Check and clean inlet hose screen. 6. Provide cooler water supply. 7. Clear blocks in outlet hose. 8. Replace spray gun. 9. Clean spray tip. 10. Contact local service facility.
Detergent fails to mix with spray.	<ol style="list-style-type: none"> 1. Detergent siphoning tube is not submerged. 2. Detergent siphoning tube/filter is clogged or cracked. 3. High pressure spray tip installed. 	<ol style="list-style-type: none"> 1. Fully submerge detergent siphoning tube into detergent. 2. Clean or replace filter/ siphoning tube. 3. Replace with low pressure spray tip.
Engine lacks power.	<ol style="list-style-type: none"> 1. Dirty air filter. 	<ol style="list-style-type: none"> 1. Replace air filter.
Engine will not start	<ol style="list-style-type: none"> 1. On/off switch in OFF position. 2. No fuel in engine 3. Faulty engine stop solenoid (if equipped) 4. Pressure build up in pump 	<ol style="list-style-type: none"> 1. Turn the switch to ON position 2. Fill fuel tank or turn on fuel supply. 3. See authorized dealer/distributor. 4. Squeeze trigger on spray wand (refer to operating instructions in owner's manual)
Oil Alert (for units with this feature)	<ol style="list-style-type: none"> 1. Engine isn't level or the oil level is too low. 	Place engine on level surface or perform an oil change using SAE 15W40 Diesel oil (refer to engine user manual for instructions)
Engine will not start or starts and runs poorly	<ol style="list-style-type: none"> 1. Low oil level 2. Dirty air filter 3. Out of diesel 4. Stale diesel 5. Water in diesel 	<ol style="list-style-type: none"> 1. Fill crankcase to proper level 2. Clean or replace air filter 3. Fill fuel tank 4. Drain gas tank and fill with fresh fuel 5. Drain gas tank, fill with fresh fuel
Engine shuts down during operation	<ol style="list-style-type: none"> 1. Out of diesel 2. Low oil level 	<ol style="list-style-type: none"> 1. Fill fuel tank 2. Fill crankcase to proper oil level
Engine lacks power	<ol style="list-style-type: none"> 1. Dirty air filter 	<ol style="list-style-type: none"> 1. Replace air filter
Black exhaust smoke	<ol style="list-style-type: none"> 1. Engine overloaded 2. Clogged air cleaner element 3. Improper diesel fuel 4. Faulty spraying of fuel injection 	<ol style="list-style-type: none"> 1. Reduce load 2. Clean element or replace 3. Replace with recommended diesel fuel. 4. See authorized dealer/distributor
White exhaust smoke	<ol style="list-style-type: none"> 1. Improper diesel fuel 	<ol style="list-style-type: none"> 1. Replace with recommended diesel fuel
	<ol style="list-style-type: none"> 2. Faulty spray pattern of fuel injection 3. Fuel injection timing delay 4. Engine burning oil 	**See authorized dealer/distributor



PUMP

Problem	Causes	Correction
No low pressure detergent delivery	<ol style="list-style-type: none">1. Using wrong nozzle2. Siphon hose or filter is plugged	<ol style="list-style-type: none">1. Insert black soaper nozzle2. Clear siphon hose of debris
Unit does not reach required pressure	<ol style="list-style-type: none">1. Restricted or insufficient water supply2. Unsuitable or worn out nozzle3. Regulator set too low (for units with an adjustable unloader)4. Blocked or debris under inlet/delivery valve	<ol style="list-style-type: none">1. Check supply hose, faucet and inlet water filter. Must be connected to water source that provides at least 6 GPM2. Replace nozzle3. Reset unloader by turning knob (clockwise increases pressure)4. Remove inlet and delivery valves and clean for debris.
Thermal Relief Valve is open and discharging water from side of pump	<ol style="list-style-type: none">1. Water temperature is too high2. Pump has operated more than 3 mins without pulling trigger	<ol style="list-style-type: none">1. Use cool water only.2. Pull trigger at least 30 seconds every 3 mins. Thermal valve must be replaced.
Leak in the fittings	<ol style="list-style-type: none">1. Water leaks in high pressure fittings, hose, or gun	<ol style="list-style-type: none">1. Use Teflon tape or pipe sealant to tighten hose fitting, replace hose or gun. **If problem continues, take to your pressure cleaner dealer.2. Check quick connect for damaged or lost O-rings and replace.
Pump oil is low	<ol style="list-style-type: none">1. Normal use consumes oil over time	<ol style="list-style-type: none">1. To gauge the oil level, look directly into the sight glass. Oil level should always be at the center dot. Do not overfill. Replace w/ SAE 30 non detergent mineral oil
Oil has a milky color	<ol style="list-style-type: none">1. Seals have worn from use and water has leaked in	<ol style="list-style-type: none">1. Bring Unit to local service center to have seals replaced



Winter Storage

NOTICE

You must protect your unit from freezing temperatures.

1. Failure to do so will permanently damage your pump and render your unit inoperable.
2. **Freezing damage is not covered under warranty.**

To protect the unit from freezing temperatures:

1. Use Pump Saver to treat the pump. This minimizes freezing damage and lubricates pistons and seals. Contact your local dealer for Pump Saver Solution.
2. If pump saver is not available, connect a 3 ft. section of garden hose to the water inlet adapter. Pour RV-antifreeze (antifreeze without alcohol) into hose. Pull the recoil handle twice. Disconnect the 3 ft. hose.
3. Store the unit in a clean, dry area (heated area preferred).

Long Term Storage

If you do not plan to use the pressure cleaner for more than 30 days, you must prepare the engine and pump for long term storage. See the engine user manual for specific instructions regarding this.

Protect Fuel System

Fuel Stabilizer:

Fuel will become stale when stored over 30 days. Stale fuel causes acids and gum deposits to form in the fuel system or on essential carburetor parts. Prior to storage, if diesel will not be treated with a fuel stabilizer, it must be drained from the engine into an approved container. After draining, run the engine until it stops from lack of fuel.

When fuel stabilizers are used according to their instructions, there is no need to drain the Diesel from the engine prior to storage. Run the engine for a short time to circulate stabilizer throughout the fuel system. Engine and fuel can then be stored for up to 24 months.

If diesel is drained, the use of a fuel stabilizer in the storage container is still recommended to maintain freshness.

Storing the Engine



See the engine operator's manual for instructions on how to properly prepare the engine for storage.

NOTE: Pump Saver is available as an optional accessory. It is not included with the pressure cleaner. Contact your closest authorized dealer to purchase BE Pump Saver.

To use Pump Saver, make sure the pressure cleaner is turned off and disconnected from supply water. Read and follow all instructions and warnings given on the Pump Saver container.

Other Storage Tips

1. DO NOT store fuel from one season to another unless it has been treated as described in *Protect Fuel System*.
2. Replace the fuel container if it starts to rust. Rust and/or dirt in fuel can cause problems if it's used with this unit.
3. Cover unit with a suitable protective cover that does not retain moisture.

 WARNING	
	Storage covers can be flammable.
<ul style="list-style-type: none">• DO NOT place a storage cover over a hot pressure cleaner.• Let equipment cool for at least 30 minutes before placing the cover on the equipment.	

4. Store unit in a clean and dry area.



Prices

All prices are current at the date of issue and subject to change without notice.

Unless otherwise stated, all quotations are valid for 7 days.

All retail prices quoted are recommendations only. There is no obligation to comply with those recommendations.

Special Builds

Any item not specifically listed as a part number in the current catalogue is considered a "special build. Special builds are not eligible for return or deferment of delivery.

Payment

Payment terms are 30 days from the end of the month, unless otherwise stated in writing.

Return of goods

Goods eligible for return must be pre-approved, in writing, by BAR. Returned goods will be subject to a 15% restocking fee to cover administration costs, plus an additional amount estimated to be BAR's cost to return the goods to new, warehouse condition.

Shipping

All products from BAR are supplied ex-Works our nearest warehouse. Where BAR agree to pay the freight for any shipment, this does not change the ex-works terms. We strongly recommend you undertake transit insurance for all shipments.



Warranty

The Trade Practices Act supersedes all warranty conditions detailed below. All products are warranted to be free from faulty materials and workmanship. This excludes fair wear and tear, improper installation or application, failure to carry out scheduled and reasonable maintenance or improper application.

For your respective engine warranty, please contact the auxiliary suppliers mentioned below –

Yanmar

Power Equipment Pty Ltd

Email: info@powerequipment.com.au

Phone: 1800 069 469

Kohler

EPG Engines

Email: info@epgengines.com.au

Phone: 1800 122 770

Hatz

Hatz Australia Pty Ltd

Email: engines@hatz.com.au

Phone: 1800 122 770

Kubota

Kubota Australia

Email: kta_g.warranty@kubota.com

Phone: 03 9394 4400

Suitability for purpose

BAR makes no representation about the suitability of a product for a specific application. Our representations relate solely to the operating performances of the product (in isolation to the application).

Reservation of Title

The rights to, and full interest and title in the goods supplied remains with BAR and does not pass to you until the goods have been fully paid for.



If you need assistance with the assembly or operation of your Pressure Cleaner please contact

02 4577 2144

sales@bargroup.com.au

November 2023