

# M350

SELF-PRIMING  
CENTRIFUGAL  
PUMPS

INTRODUCING

## FILL FASTER. SPRAY MORE.

### 500+ GPM INDUSTRY-LEADING FLOW.



M350PVAN14W  
GAS ENGINE MODEL

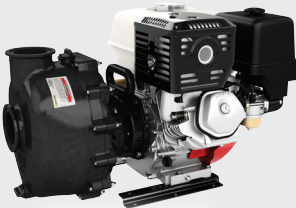

M350PH13W  
GAS ENGINE MODEL



M350PE15W  
ELECTRIC MOTOR MODEL

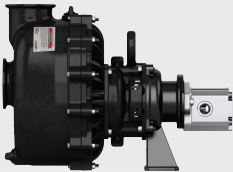

M350PHYW  
HYDRAULIC MODEL



M350PBW  
BEARING PEDESTAL MODEL



M350POW  
PUMP ONLY MODEL



M350POEW  
PUMP ONLY MODEL  
FOR ELECTRIC MOTOR

The new M350 pump saves money in spraying operations.

M350 **FastFlow™** technology utilizing a customized diffuser design greatly increases flow rates. With performance over 500 gallons per minute (see chart), you'll spend less time filling, which means less downtime in the field and most importantly, less cost per acre.



**MAX FLOW**  
3" SUCTION    **MAX FLOW**  
4" SUCTION

BANJO PUMPS	M350		
	MAX FLOW		
	3" SUCTION	4" SUCTION	
	GAS ENGINE	450 GPM	515 GPM
	ELECTRIC MOTOR	450 GPM	515 GPM
HYDRAULIC MOTOR	450 GPM	500 GPM	
LEADING COMPETITOR	424 GPM	449 GPM	
BANJO ADVANTAGE	6.1%	14.5%	

\*Using flooded suction piping.

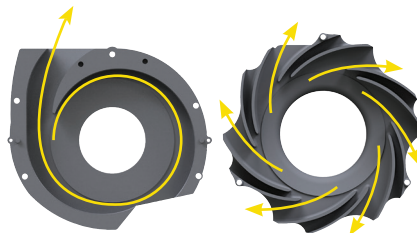

Standard  
volute design

**FastFlow™**  
diffuser design

The FastFlow diffuser design incorporates multiple channels that maximize fluid flow through the pump outperforming traditional one channel volute designs.

See table on back for 4" fittings that maximize flow.

### NO LEAKS. NO WEAR. NO WORRIES.

Patented tandem wet seal design:

- Produces less wear
- Prevents seal breakage from high pressure clean out
- Eliminates eight leak points
- Works with natural system pressure to keep seal intact.
- Withstands over one hour of dry run.

M350's Tandem Wet Seals

Traditional Opposed Wet Seals

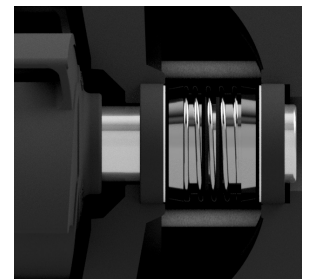
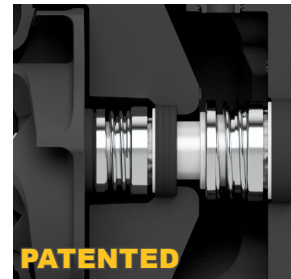

**PATENTED**

With tandem wet seals, pressure within the pump body acts in the same direction as the inner seal spring, holding the seal closed preventing leaks. Traditional opposed wet seals can be forced open by high internal pump pressure - causing leaks.

### ATTACHES EASILY.

The M350 Pump Only is manufactured fully assembled and ready for immediate use. The unique design of the M350 Pump Only allows for easy replacement and retrofitting, saving time and effort (up to 30 minutes).

# SPECIFICATIONS

- Patented tandem wet seal design
- Run dry capability of greater than one hour
- Industry-leading burst pressure
- Wetted components are glass-filled polypropylene or stainless steel
- All 300 series stainless steel hardware
- EPDM seals for broad chemical resistance
- Standard manifold inlet and outlet for easy plumbing
- With safety guard installed, no exposure to moving parts
- Typical operating speed: 3600 RPM
- Capable of handling occasional solid particles up to ½" in diameter
- Maximum self-priming height 25 ft (7.6 m)
- Hydraulic model optimized for suction lift
- Other models optimized for flooded suction

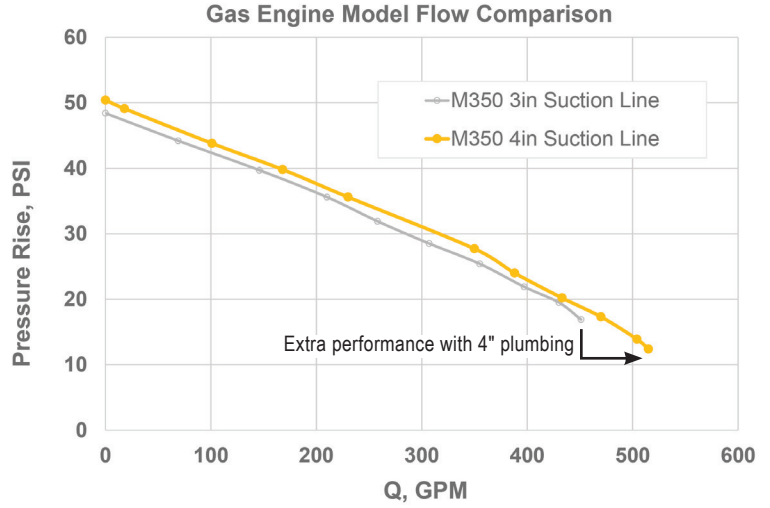

\*Using flooded suction piping.

# PUMP MODEL CHART

		POLYPROPYLENE	
		3"	
BANJO PUMPS	WET SEAL GAS ENGINE	✓	✓
	WET SEAL ELECTRIC MOTOR	✓	✓
	WET SEAL HYDRAULIC MOTOR	✓	✓
	WET SEAL BEARING PEDESTAL	✓	✓
	WET SEAL PUMP ONLY	✓	✓

4" PLUMBING FITTINGS	
M300400A	3" Manifold x 4" Male Coupler
M300400BRB	3" Manifold x 4" Hose Barb

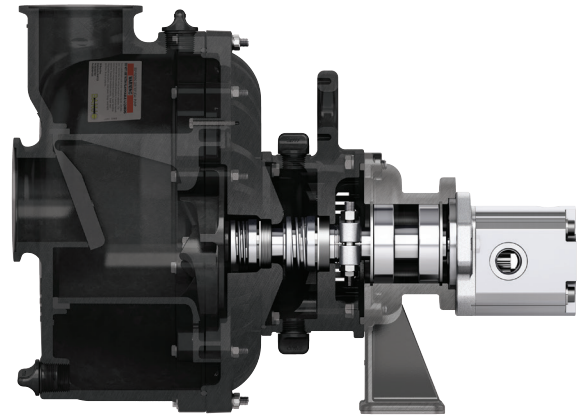

**BANJO CORPORATION**  
 A Unit of IDEX Corporation  
 150 Banjo Drive  
 Crawfordsville, IN 47933 U.S.A.  
 Telephone: (765) 362-7367  
 Fax: (765) 362-0744  
[banjocorp.com](http://banjocorp.com)

To learn more about the M350 family, scan this QR code or visit:

[BanjoCorp.com/M350](http://BanjoCorp.com/M350)

